

**MAHANALUA NUI SUB'D.
PHASE IV**

LAUNIUPOKO, LAHAINA, MAUI, HAWAII
 TMK: 2nd Div. 4-7-009:035, 036 & 037
 TMK: 2nd Div. 4-7-010:008, 009 & 010

TRUE NORTH

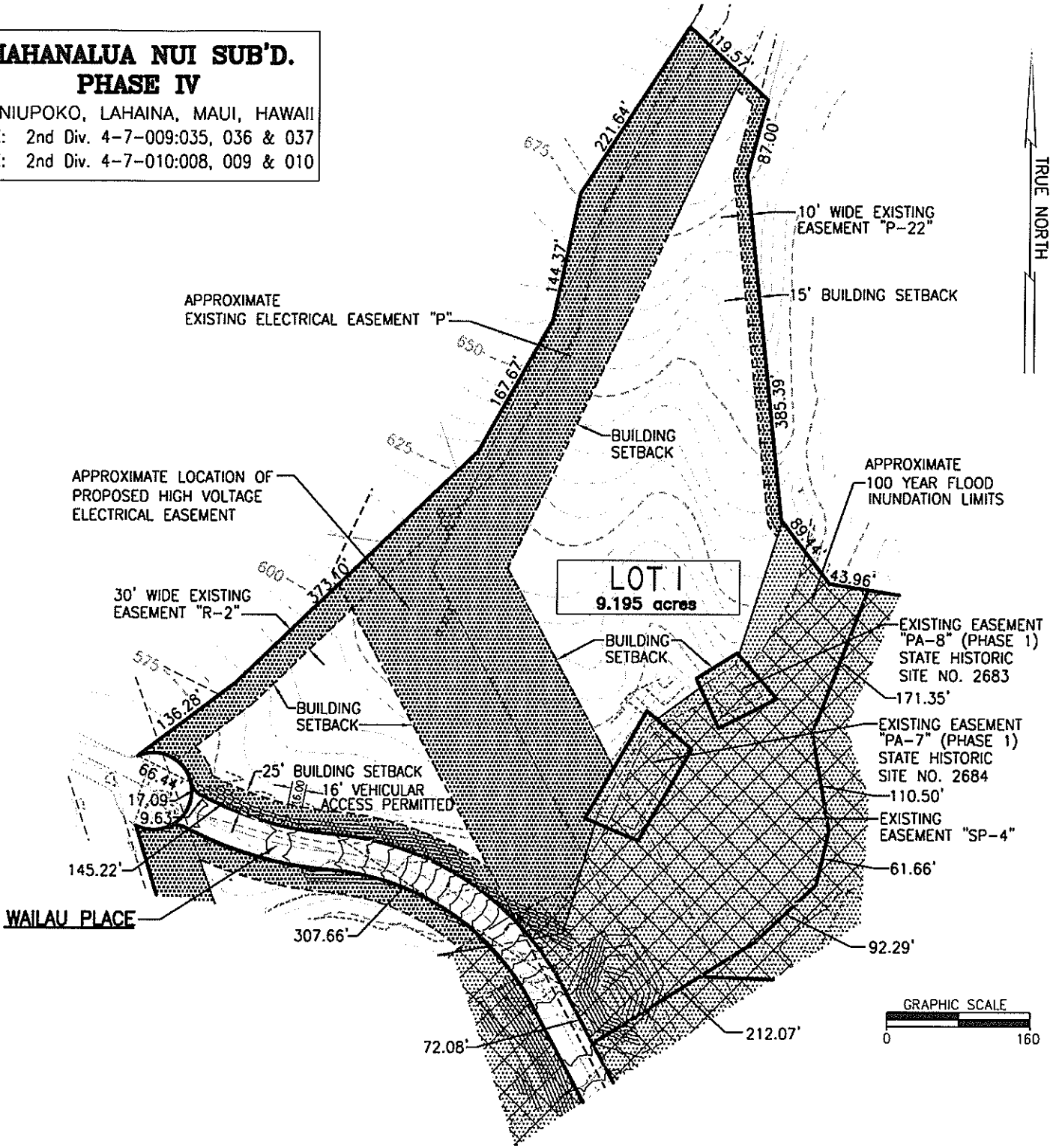

LOT 1
9.195 acres

WAILAU PLACE

LEGEND	
	ARCH. BUFFER/ STREAMBED PARK
	SETBACK/EASEMENT
	100 YEAR FLOOD INUNDATION LIMITS
	NO ACCESS PERMITTED
	ACCESS PERMITTED

- NOTE:**
- ELEVATIONS DERIVED FROM CONSTRUCTION PLANS AND AERIAL TOPOGRAPHIC MAP. TOPOGRAPHIC CONTOURS ARE APPROXIMATE.
 - ALL OWNERS ARE REQUIRED TO RETAIN ALL STORMWATER RUNOFF GENERATED BY IMPROVEMENTS TO THE PROPERTY. NO ADDITIONAL OR ALTERED FLOW IS PERMITTED ON NEIGHBOR PARCELS.
 - MAXIMUM ROOF ELEVATION AND BUILDING SETBACKS ARE DETERMINED BY MAUI COUNTY CODE.
 - THIS IS AN AGRICULTURALLY DESIGNATED AND ZONED PROPERTY. CONSULT HRS 205-4.5 AND MAUI COUNTY TITLE 19 FOR PERMITTED USES OF AGRICULTURAL LANDS.

PRELIMINARY PLOT PLAN

**MAHANALUA NUI SUB'D.
PHASE IV**

LAUNIUPOKO, LAHAINA, MAUI, HAWAII
 TMK: 2nd Div. 4-7-009:035, 036 & 037
 TMK: 2nd Div. 4-7-010:008, 009 & 010

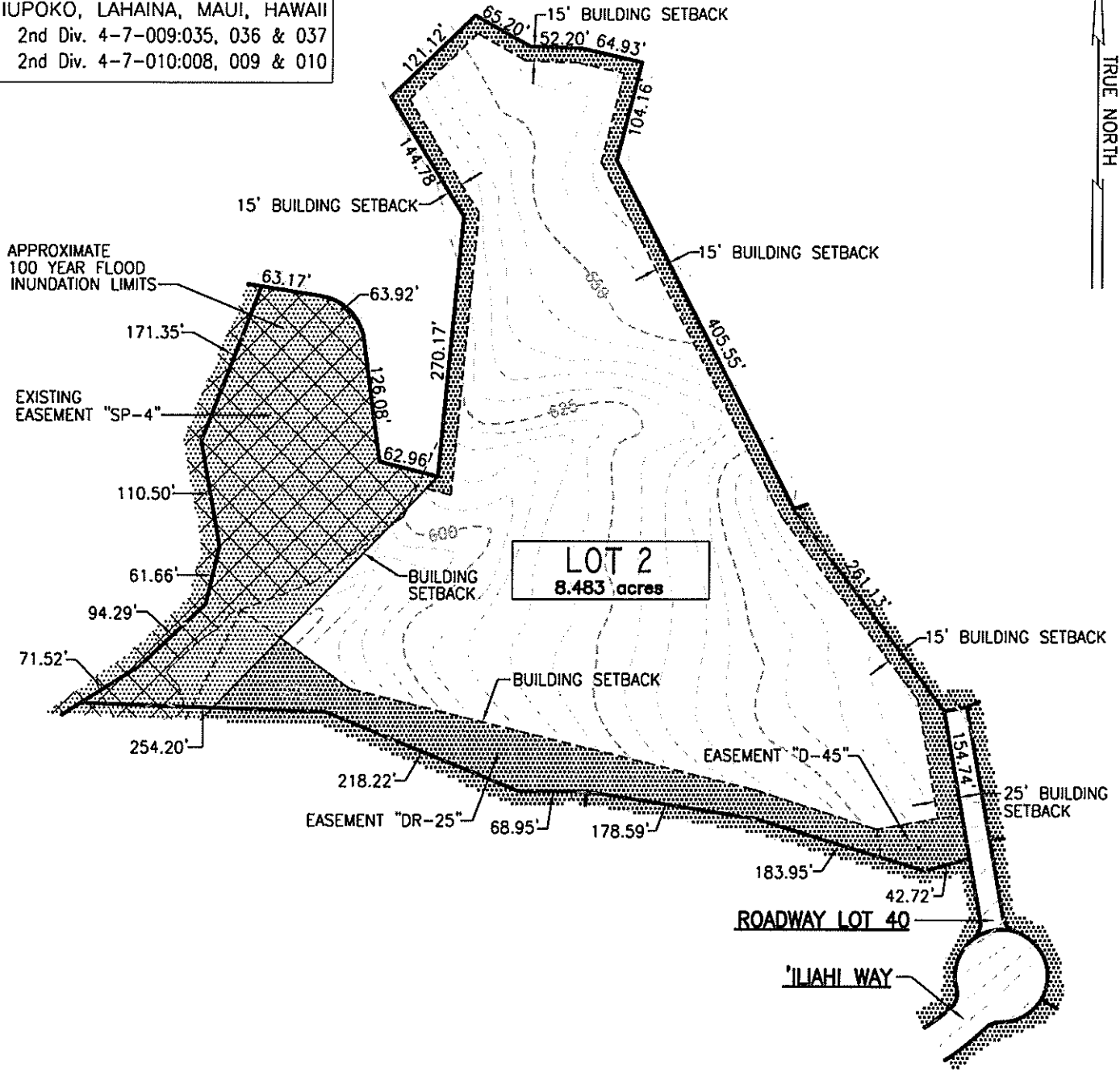

LEGEND	
	ARCH. BUFFER/ STREAMBED PARK
	SETBACK/EASEMENT
	100 YEAR FLOOD INUNDATION LIMITS
	NO ACCESS PERMITTED
	ACCESS PERMITTED

- NOTE:
1. ELEVATIONS DERIVED FROM CONSTRUCTION PLANS AND AERIAL TOPOGRAPHIC MAP. TOPOGRAPHIC CONTOURS ARE APPROXIMATE.
 2. ALL OWNERS ARE REQUIRED TO RETAIN ALL STORMWATER RUNOFF GENERATED BY IMPROVEMENTS TO THE PROPERTY. NO ADDITIONAL OR ALTERED FLOW IS PERMITTED ON NEIGHBOR PARCELS.
 3. MAXIMUM ROOF ELEVATION AND BUILDING SETBACKS ARE DETERMINED BY MAUI COUNTY CODE.
 4. THIS IS AN AGRICULTURALLY DESIGNATED AND ZONED PROPERTY. CONSULT HRS 205-4.5 AND MAUI COUNTY TITLE 19 FOR PERMITTED USES OF AGRICULTURAL LANDS.

PRELIMINARY PLOT PLAN

**MAHANALUA NUI SUB'D.
PHASE IV**

LAUNIUPOKO, LAHAINA, MAUI, HAWAII
 TMK: 2nd Div. 4-7-009:035, 036 & 037
 TMK: 2nd Div. 4-7-010:008, 009 & 010

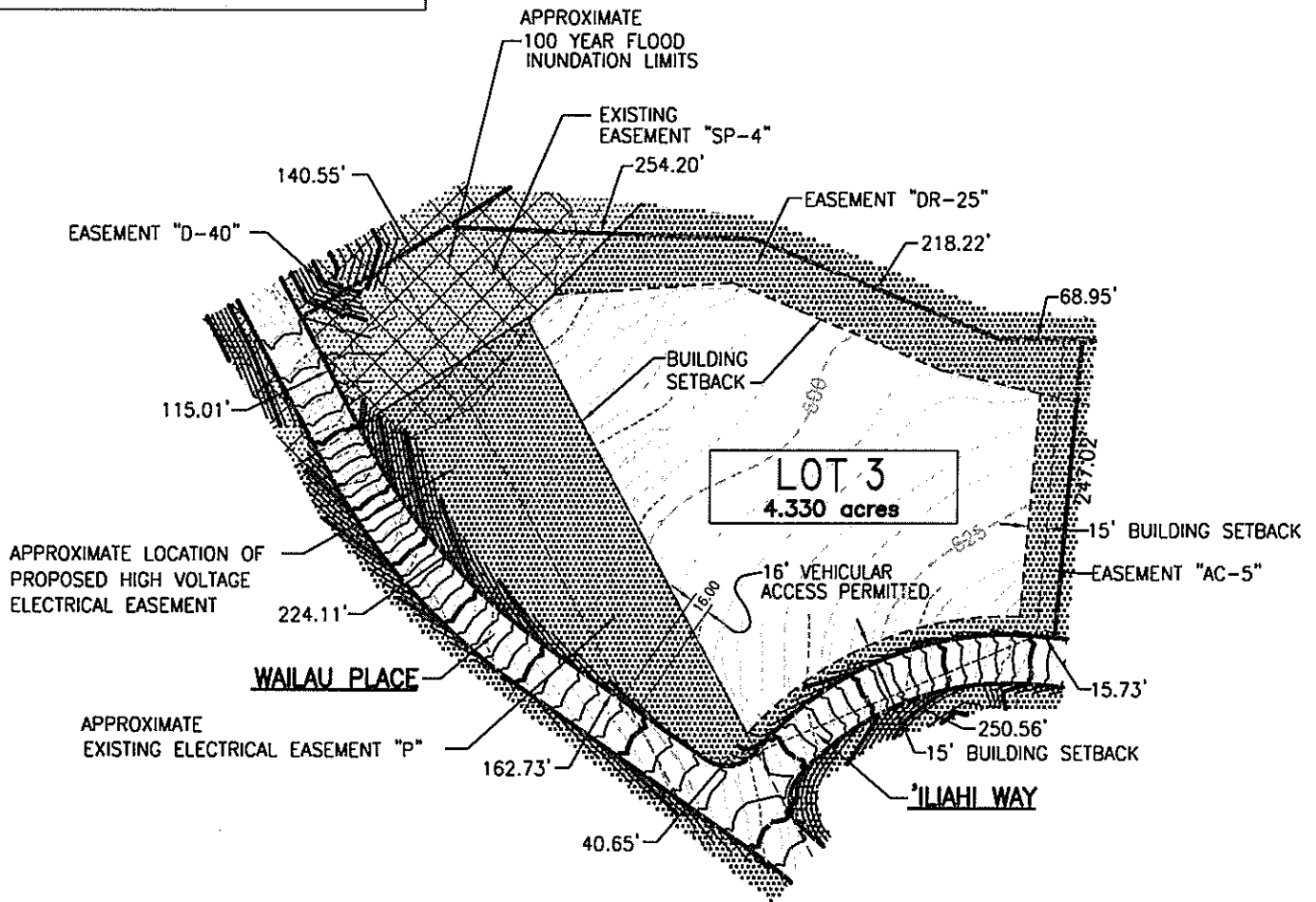
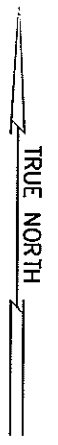

LEGEND	
	ARCH. BUFFER/ STREAMBED PARK
	SETBACK/EASEMENT
	100 YEAR FLOOD INUNDATION LIMITS
	NO ACCESS PERMITTED
	ACCESS PERMITTED

NOTE:

1. ELEVATIONS DERIVED FROM CONSTRUCTION PLANS AND AERIAL TOPOGRAPHIC MAP. TOPOGRAPHIC CONTOURS ARE APPROXIMATE.
2. ALL OWNERS ARE REQUIRED TO RETAIN ALL STORMWATER RUNOFF GENERATED BY IMPROVEMENTS TO THE PROPERTY. NO ADDITIONAL OR ALTERED FLOW IS PERMITTED ON NEIGHBOR PARCELS.
3. MAXIMUM ROOF ELEVATION AND BUILDING SETBACKS ARE DETERMINED BY MAUI COUNTY CODE.
4. THIS IS AN AGRICULTURALLY DESIGNATED AND ZONED PROPERTY. CONSULT HRS 205-4.5 AND MAUI COUNTY TITLE 19 FOR PERMITTED USES OF AGRICULTURAL LANDS.

PRELIMINARY PLOT PLAN

**MAHANALUA NUI SUB'D.
PHASE IV**

LAUNIUPOKO, LAHAINA, MAUI, HAWAII
 TMK: 2nd Div. 4-7-009:035, 036 & 037
 TMK: 2nd Div. 4-7-010:008, 009 & 010

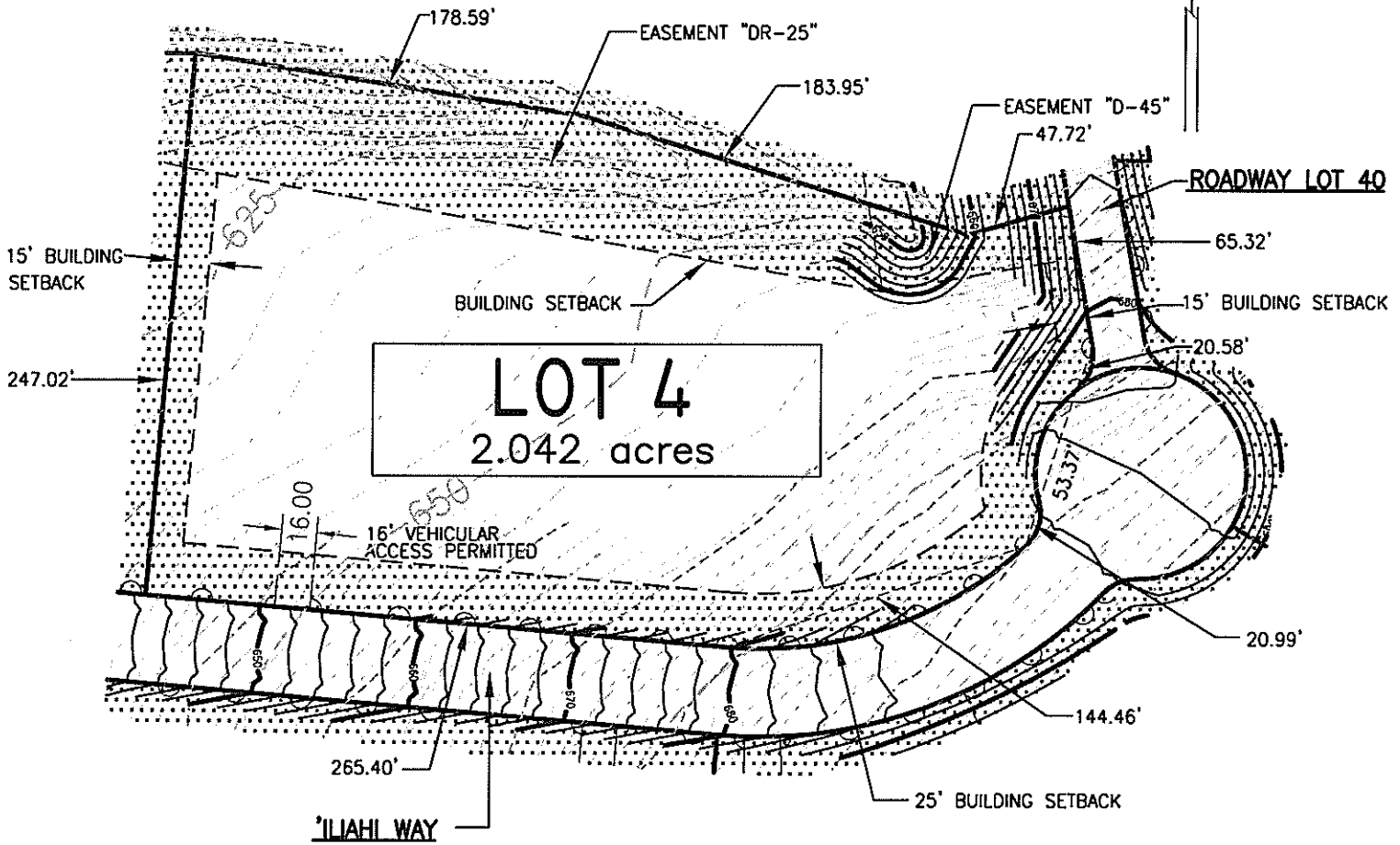
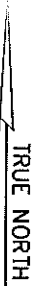

LEGEND	
	ARCH. BUFFER/ STREAMBED PARK
	SETBACK/EASEMENT
	100 YEAR FLOOD INUNDATION LIMITS
	NO ACCESS PERMITTED
	ACCESS PERMITTED

- NOTE:
- ELEVATIONS DERIVED FROM CONSTRUCTION PLANS AND AERIAL TOPOGRAPHIC MAP. TOPOGRAPHIC CONTOURS ARE APPROXIMATE.
 - ALL OWNERS ARE REQUIRED TO RETAIN ALL STORMWATER RUNOFF GENERATED BY IMPROVEMENTS TO THE PROPERTY. NO ADDITIONAL OR ALTERED FLOW IS PERMITTED ON NEIGHBOR PARCELS.
 - MAXIMUM ROOF ELEVATION AND BUILDING SETBACKS ARE DETERMINED BY MAUI COUNTY CODE.
 - THIS IS AN AGRICULTURALLY DESIGNATED AND ZONED PROPERTY. CONSULT HRS 205-4.5 AND MAUI COUNTY TITLE 19 FOR PERMITTED USES OF AGRICULTURAL LANDS.

PRELIMINARY PLOT PLAN



**MAHANALUA NUI SUB'D.
PHASE IV**

LAUNIUPOKO, LAHAINA, MAUI, HAWAII
 TMK: 2nd Div. 4-7-009:035, 036 & 037
 TMK: 2nd Div. 4-7-010:008, 009 & 010

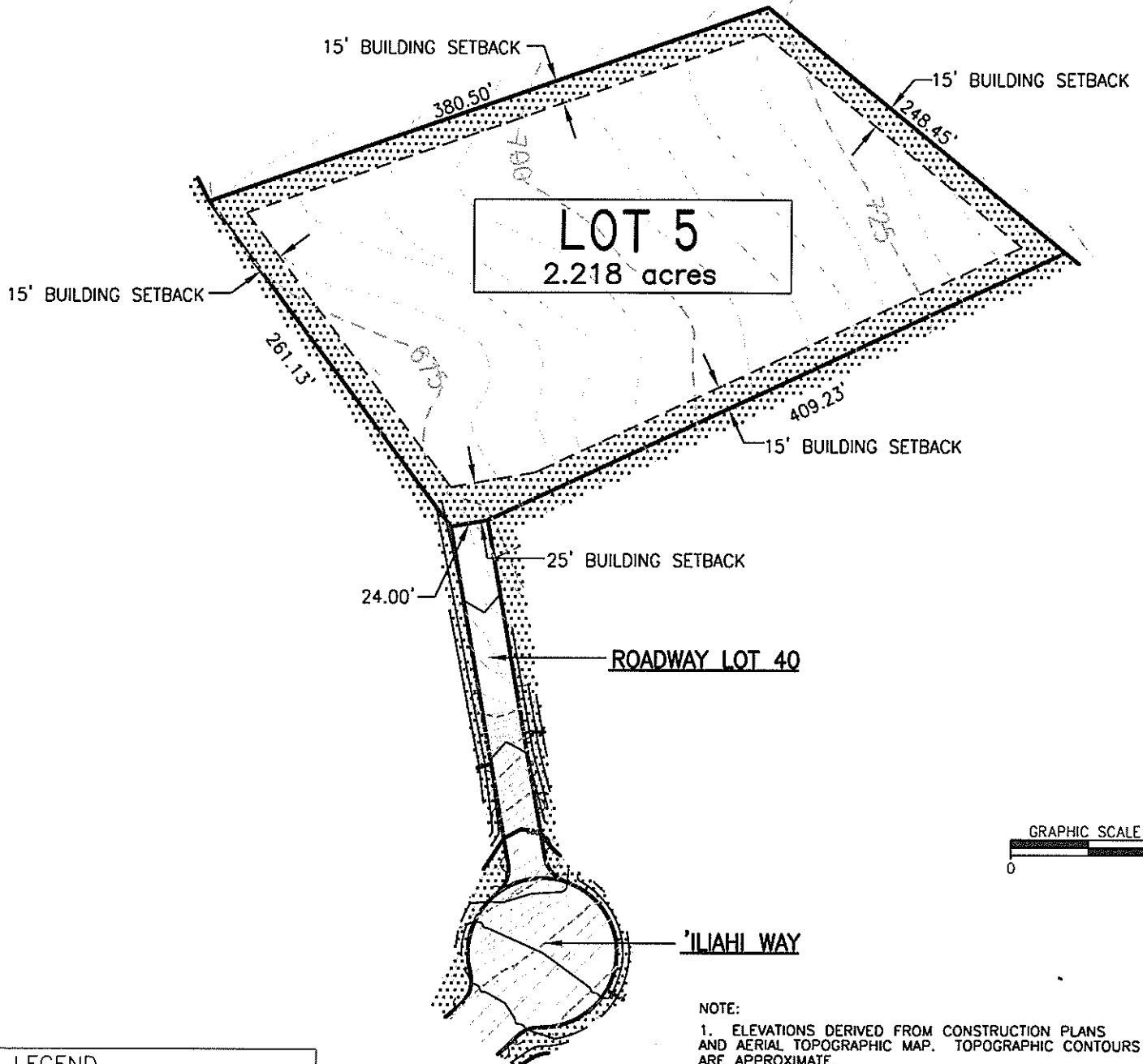
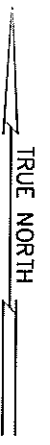

LEGEND	
	ARCH. BUFFER/ STREAMBED PARK
	SETBACK/EASEMENT
	100 YEAR FLOOD INUNDATION LIMITS
	NO ACCESS PERMITTED
	ACCESS PERMITTED

- NOTE:
1. ELEVATIONS DERIVED FROM CONSTRUCTION PLANS AND AERIAL TOPOGRAPHIC MAP. TOPOGRAPHIC CONTOURS ARE APPROXIMATE.
 2. ALL OWNERS ARE REQUIRED TO RETAIN ALL STORMWATER RUNOFF GENERATED BY IMPROVEMENTS TO THE PROPERTY. NO ADDITIONAL OR ALTERED FLOW IS PERMITTED ON NEIGHBOR PARCELS.
 3. MAXIMUM ROOF ELEVATION AND BUILDING SETBACKS ARE DETERMINED BY MAUI COUNTY CODE.
 4. THIS IS AN AGRICULTURALLY DESIGNATED AND ZONED PROPERTY. CONSULT HRS 205-4.5 AND MAUI COUNTY TITLE 19 FOR PERMITTED USES OF AGRICULTURAL LANDS.

PRELIMINARY PLOT PLAN

**MAHANALUA NUI SUB'D.
PHASE IV**

LAUNIUPOKO, LAHAINA, MAUI, HAWAII
 TMK: 2nd Div. 4-7-009:035, 036 & 037
 TMK: 2nd Div. 4-7-010:008, 009 & 010

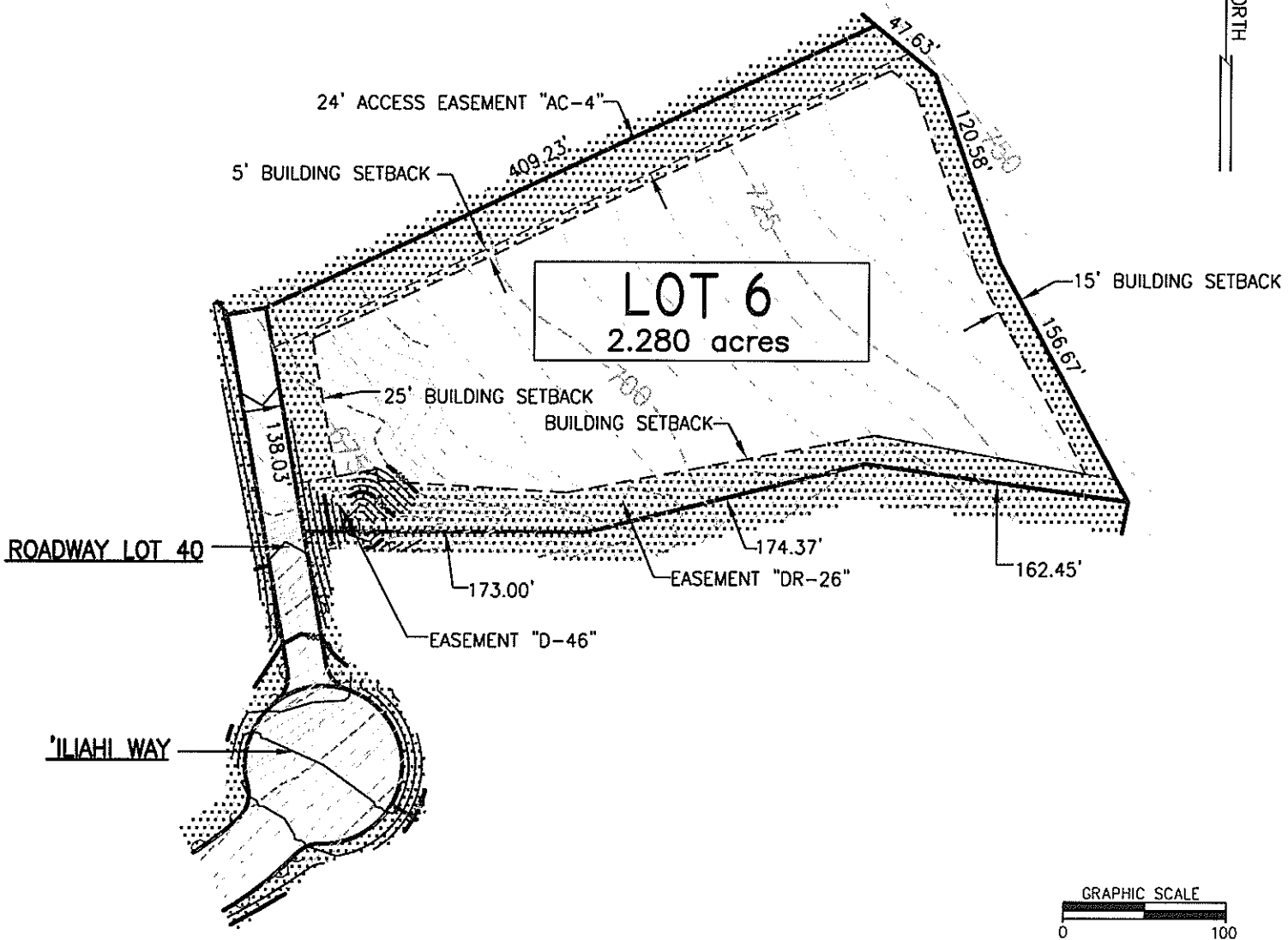
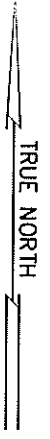

LEGEND	
	ARCH. BUFFER/ STREAMBED PARK
	SETBACK/EASEMENT
	100 YEAR FLOOD INUNDATION LIMITS
	NO ACCESS PERMITTED
	ACCESS PERMITTED

- NOTE:
1. ELEVATIONS DERIVED FROM CONSTRUCTION PLANS AND AERIAL TOPOGRAPHIC MAP. TOPOGRAPHIC CONTOURS ARE APPROXIMATE.
 2. ALL OWNERS ARE REQUIRED TO RETAIN ALL STORMWATER RUNOFF GENERATED BY IMPROVEMENTS TO THE PROPERTY. NO ADDITIONAL OR ALTERED FLOW IS PERMITTED ON NEIGHBOR PARCELS.
 3. MAXIMUM ROOF ELEVATION AND BUILDING SETBACKS ARE DETERMINED BY MAUI COUNTY CODE.
 4. THIS IS AN AGRICULTURALLY DESIGNATED AND ZONED PROPERTY. CONSULT HRS 205-4.5 AND MAUI COUNTY TITLE 19 FOR PERMITTED USES OF AGRICULTURAL LANDS.

PRELIMINARY PLOT PLAN

**MAHANALUA NUI SUB'D.
PHASE IV**

LAUNIUPOKO, LAHAINA, MAUI, HAWAII
 TMK: 2nd Div. 4-7-009:035, 036 & 037
 TMK: 2nd Div. 4-7-010:008, 009 & 010

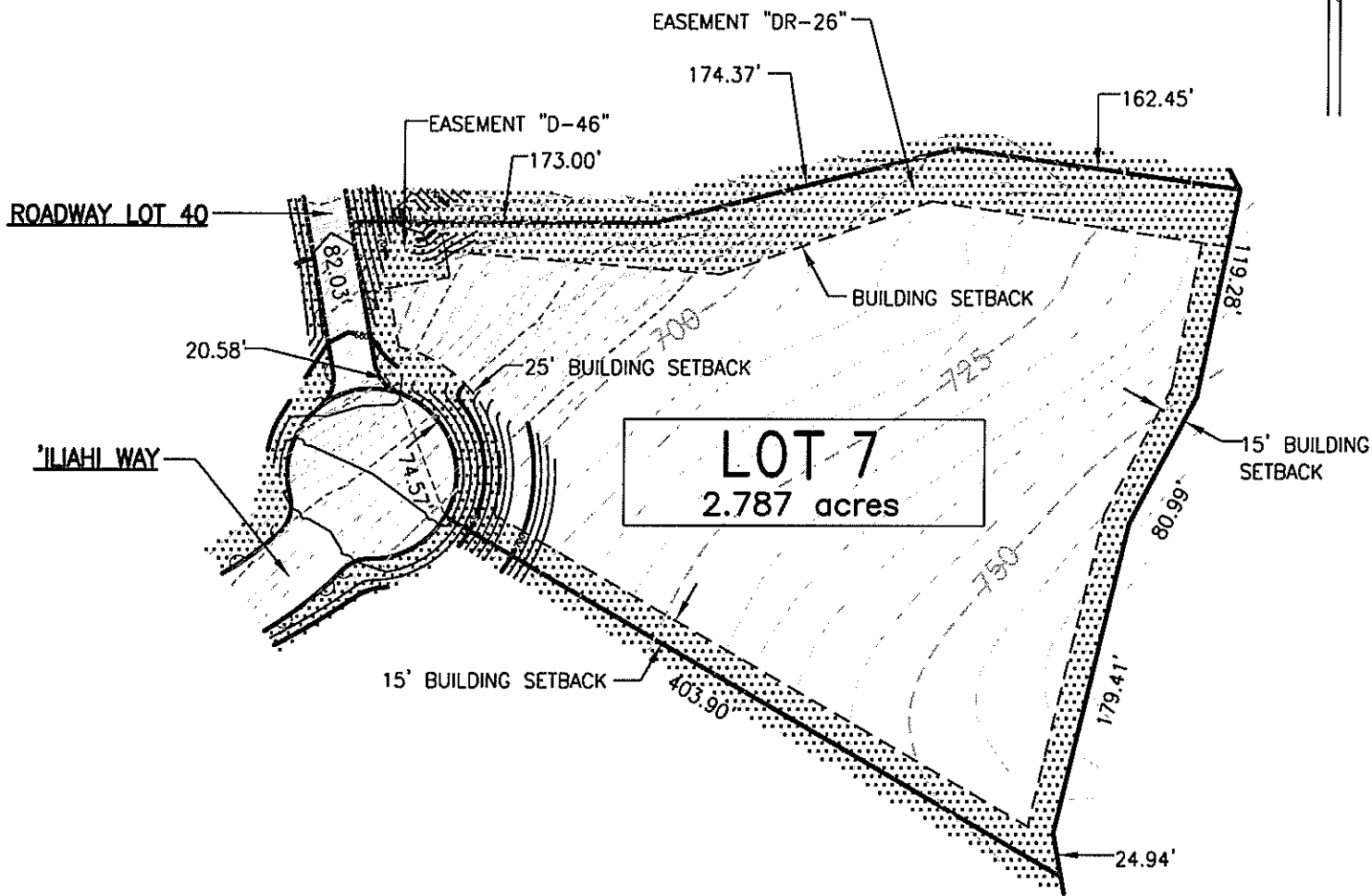
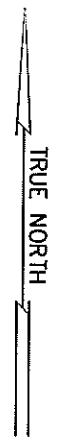

LOT 7
2.787 acres



LEGEND	
	ARCH. BUFFER/ STREAMBED PARK
	SETBACK/EASEMENT
	100 YEAR FLOOD INUNDATION LIMITS
	NO ACCESS PERMITTED
	ACCESS PERMITTED

- NOTE:
1. ELEVATIONS DERIVED FROM CONSTRUCTION PLANS AND AERIAL TOPOGRAPHIC MAP. TOPOGRAPHIC CONTOURS ARE APPROXIMATE.
 2. ALL OWNERS ARE REQUIRED TO RETAIN ALL STORMWATER RUNOFF GENERATED BY IMPROVEMENTS TO THE PROPERTY. NO ADDITIONAL OR ALTERED FLOW IS PERMITTED ON NEIGHBOR PARCELS.
 3. MAXIMUM ROOF ELEVATION AND BUILDING SETBACKS ARE DETERMINED BY MAUI COUNTY CODE.
 4. THIS IS AN AGRICULTURALLY DESIGNATED AND ZONED PROPERTY. CONSULT HRS 205-4.5 AND MAUI COUNTY TITLE 19 FOR PERMITTED USES OF AGRICULTURAL LANDS.

PRELIMINARY PLOT PLAN

**MAHANALUA NUI SUB'D.
PHASE IV**

LAUNIUPOKO, LAHAINA, MAUI, HAWAII
 TMK: 2nd Div. 4-7-009:035, 036 & 037
 TMK: 2nd Div. 4-7-010:008, 009 & 010

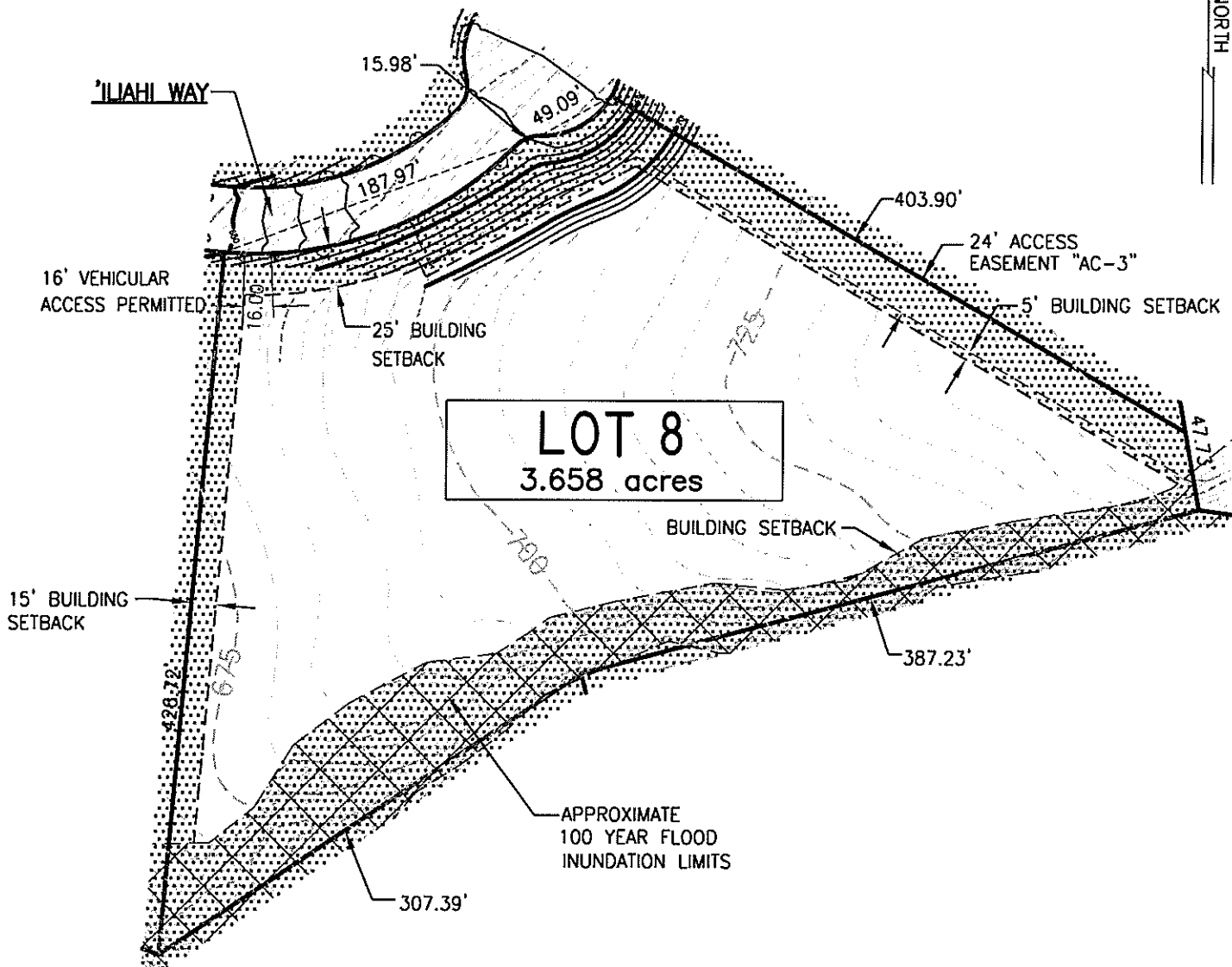
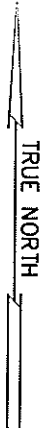

LEGEND	
	ARCH. BUFFER/ STREAMBED PARK
	SETBACK/EASEMENT
	100 YEAR FLOOD INUNDATION LIMITS
	NO ACCESS PERMITTED
	ACCESS PERMITTED

- NOTE:
1. ELEVATIONS DERIVED FROM CONSTRUCTION PLANS AND AERIAL TOPOGRAPHIC MAP. TOPOGRAPHIC CONTOURS ARE APPROXIMATE.
 2. ALL OWNERS ARE REQUIRED TO RETAIN ALL STORMWATER RUNOFF GENERATED BY IMPROVEMENTS TO THE PROPERTY. NO ADDITIONAL OR ALTERED FLOW IS PERMITTED ON NEIGHBOR PARCELS.
 3. MAXIMUM ROOF ELEVATION AND BUILDING SETBACKS ARE DETERMINED BY MAUI COUNTY CODE.
 4. THIS IS AN AGRICULTURALLY DESIGNATED AND ZONED PROPERTY. CONSULT HRS 205-4.5 AND MAUI COUNTY TITLE 19 FOR PERMITTED USES OF AGRICULTURAL LANDS.

PRELIMINARY PLOT PLAN

**MAHANALUA NUI SUB'D.
PHASE IV**

LAUNIUPOKO, LAHAINA, MAUI, HAWAII
 TMK: 2nd Div. 4-7-009:035, 036 & 037
 TMK: 2nd Div. 4-7-010:008, 009 & 010

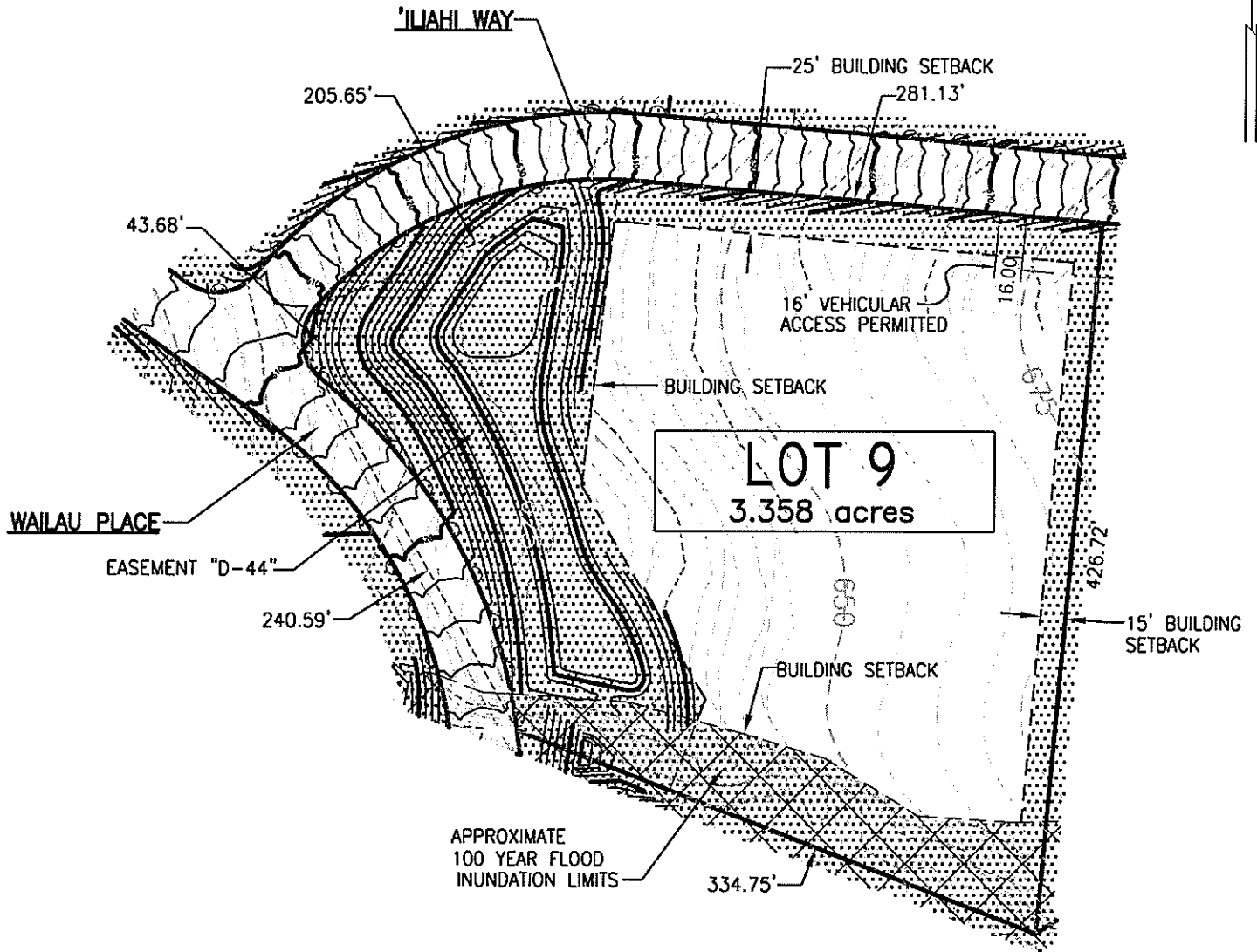
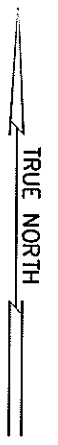

LOT 9
3.358 acres



LEGEND	
	ARCH. BUFFER/ STREAMBED PARK
	SETBACK/EASEMENT
	100 YEAR FLOOD INUNDATION LIMITS
	NO ACCESS PERMITTED
	ACCESS PERMITTED

- NOTE:
- ELEVATIONS DERIVED FROM CONSTRUCTION PLANS AND AERIAL TOPOGRAPHIC MAP. TOPOGRAPHIC CONTOURS ARE APPROXIMATE.
 - ALL OWNERS ARE REQUIRED TO RETAIN ALL STORMWATER RUNOFF GENERATED BY IMPROVEMENTS TO THE PROPERTY. NO ADDITIONAL OR ALTERED FLOW IS PERMITTED ON NEIGHBOR PARCELS.
 - MAXIMUM ROOF ELEVATION AND BUILDING SETBACKS ARE DETERMINED BY MAUI COUNTY CODE.
 - THIS IS AN AGRICULTURALLY DESIGNATED AND ZONED PROPERTY. CONSULT HRS 205-4.5 AND MAUI COUNTY TITLE 19 FOR PERMITTED USES OF AGRICULTURAL LANDS.

PRELIMINARY PLOT PLAN

**MAHANALUA NUI SUB'D.
PHASE IV**

LAUNIUPOKO, LAHAINA, MAUI, HAWAII
 TMK: 2nd Div. 4-7-009:035, 036 & 037
 TMK: 2nd Div. 4-7-010:008, 009 & 010

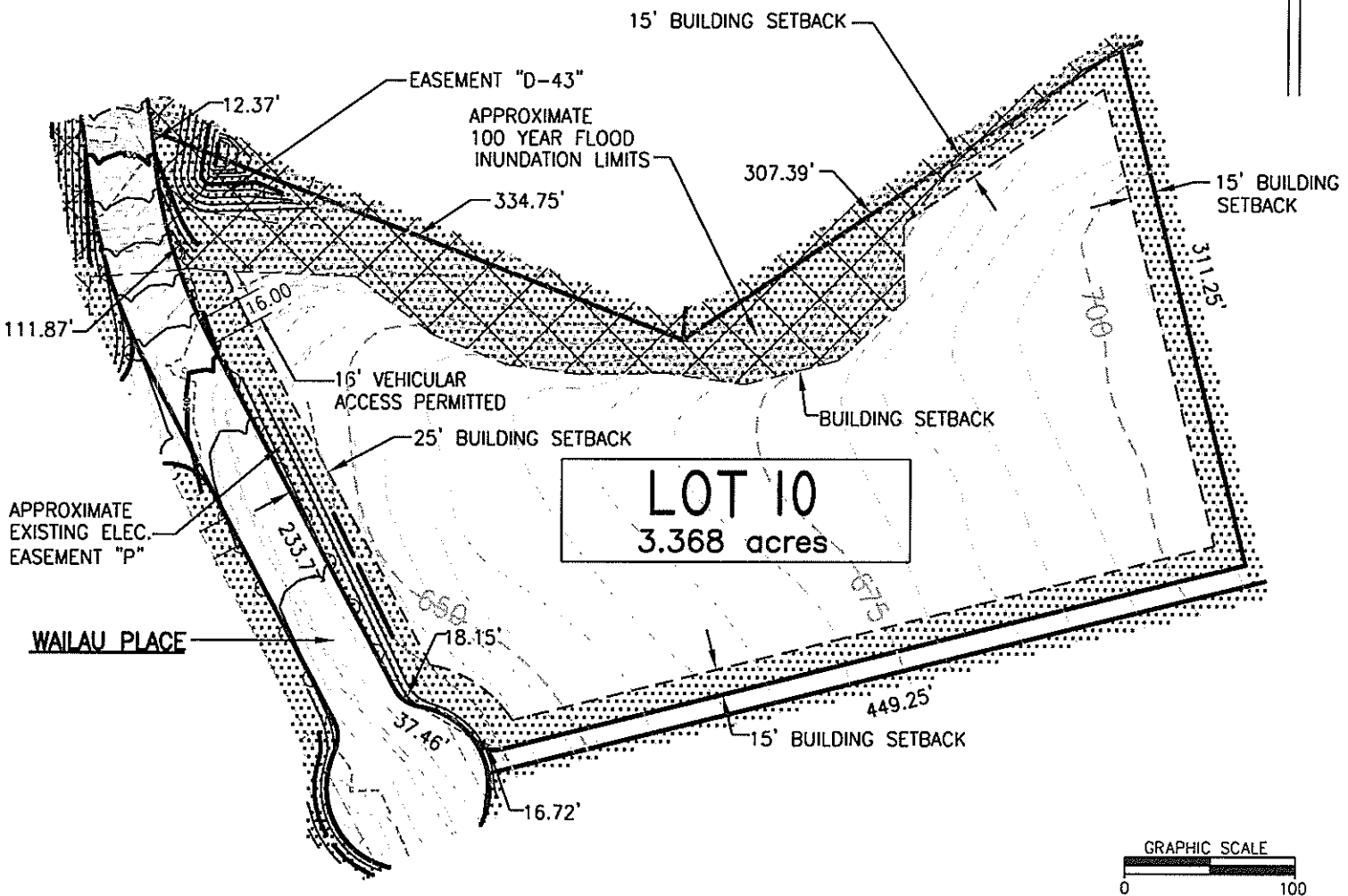

LEGEND	
	ARCH. BUFFER/ STREAMBED PARK
	SETBACK/EASEMENT
	100 YEAR FLOOD INUNDATION LIMITS
	NO ACCESS PERMITTED
	ACCESS PERMITTED

- NOTE:
1. ELEVATIONS DERIVED FROM CONSTRUCTION PLANS AND AERIAL TOPOGRAPHIC MAP. TOPOGRAPHIC CONTOURS ARE APPROXIMATE.
 2. ALL OWNERS ARE REQUIRED TO RETAIN ALL STORMWATER RUNOFF GENERATED BY IMPROVEMENTS TO THE PROPERTY. NO ADDITIONAL OR ALTERED FLOW IS PERMITTED ON NEIGHBOR PARCELS.
 3. MAXIMUM ROOF ELEVATION AND BUILDING SETBACKS ARE DETERMINED BY MAUI COUNTY CODE.
 4. THIS IS AN AGRICULTURALLY DESIGNATED AND ZONED PROPERTY. CONSULT HRS 205-4.5 AND MAUI COUNTY TITLE 19 FOR PERMITTED USES OF AGRICULTURAL LANDS.

PRELIMINARY PLOT PLAN

**MAHANALUA NUI SUB'D.
PHASE IV**

LAUNIUPOKO, LAHAINA, MAUI, HAWAII
 TMK: 2nd Div. 4-7-009:035, 036 & 037
 TMK: 2nd Div. 4-7-010:008, 009 & 010

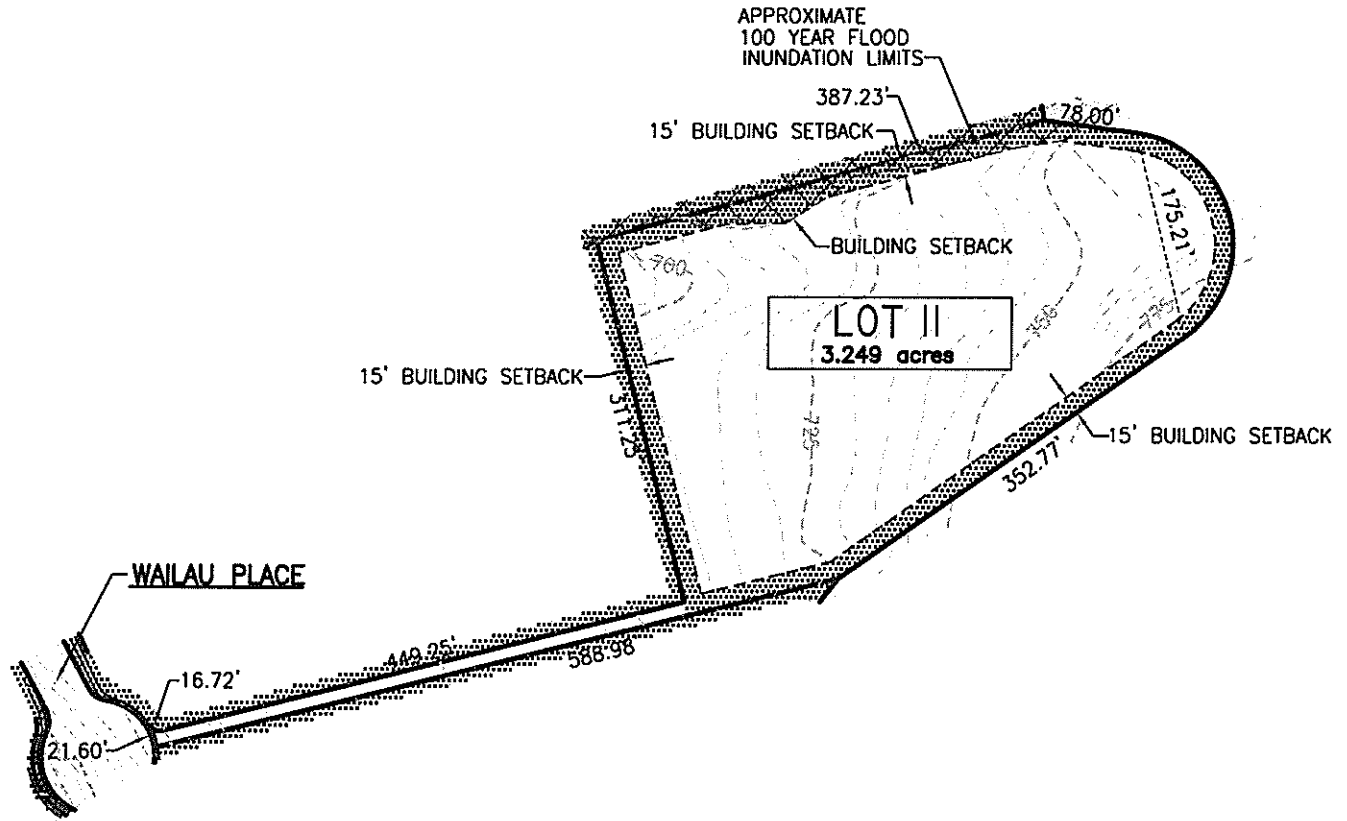

LEGEND	
	ARCH. BUFFER/ STREAMBED PARK
	SETBACK/EASEMENT
	100 YEAR FLOOD INUNDATION LIMITS
	NO ACCESS PERMITTED
	ACCESS PERMITTED

- NOTE:
1. ELEVATIONS DERIVED FROM CONSTRUCTION PLANS AND AERIAL TOPOGRAPHIC MAP. TOPOGRAPHIC CONTOURS ARE APPROXIMATE.
 2. ALL OWNERS ARE REQUIRED TO RETAIN ALL STORMWATER RUNOFF GENERATED BY IMPROVEMENTS TO THE PROPERTY. NO ADDITIONAL OR ALTERED FLOW IS PERMITTED ON NEIGHBOR PARCELS.
 3. MAXIMUM ROOF ELEVATION AND BUILDING SETBACKS ARE DETERMINED BY MAUI COUNTY CODE.
 4. THIS IS AN AGRICULTURALLY DESIGNATED AND ZONED PROPERTY. CONSULT HRS 205-4.5 AND MAUI COUNTY TITLE 19 FOR PERMITTED USES OF AGRICULTURAL LANDS.

PRELIMINARY PLOT PLAN

**MAHANALUA NUI SUB'D.
PHASE IV**

LAUNIUPOKO, LAHAINA, MAUI, HAWAII
 TMK: 2nd Div. 4-7-009:035, 036 & 037
 TMK: 2nd Div. 4-7-010:008, 009 & 010

TRUE NORTH

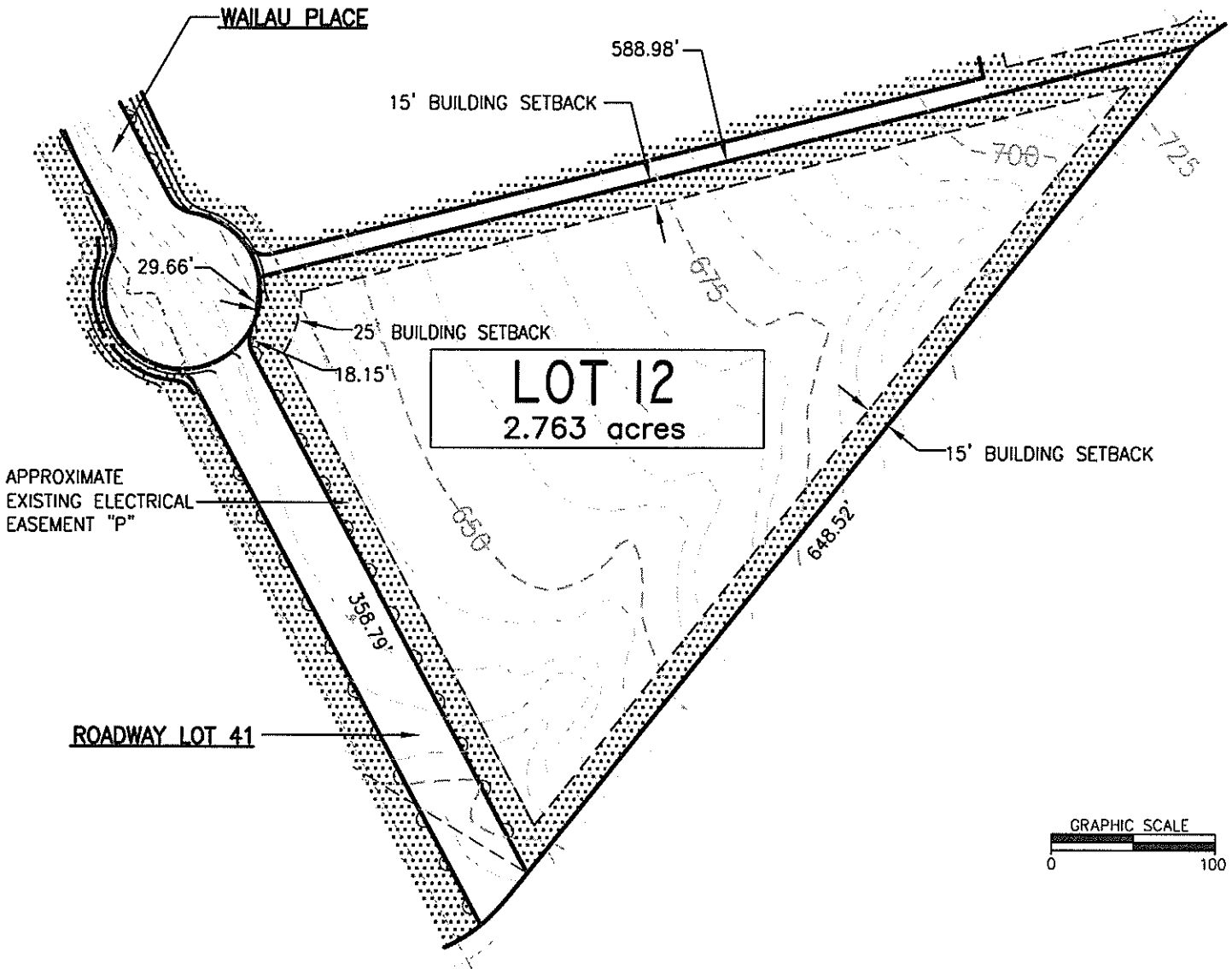

APPROXIMATE
EXISTING ELECTRICAL
EASEMENT "P"

ROADWAY LOT 41

LOT 12
2.763 acres



LEGEND	
	ARCH. BUFFER/ STREAMBED PARK
	SETBACK/EASEMENT
	100 YEAR FLOOD INUNDATION LIMITS
	NO ACCESS PERMITTED
	ACCESS PERMITTED

- NOTE:
- ELEVATIONS DERIVED FROM CONSTRUCTION PLANS AND AERIAL TOPOGRAPHIC MAP. TOPOGRAPHIC CONTOURS ARE APPROXIMATE.
 - ALL OWNERS ARE REQUIRED TO RETAIN ALL STORMWATER RUNOFF GENERATED BY IMPROVEMENTS TO THE PROPERTY. NO ADDITIONAL OR ALTERED FLOW IS PERMITTED ON NEIGHBOR PARCELS.
 - MAXIMUM ROOF ELEVATION AND BUILDING SETBACKS ARE DETERMINED BY MAUI COUNTY CODE.
 - THIS IS AN AGRICULTURALLY DESIGNATED AND ZONED PROPERTY. CONSULT HRS 205-4.5 AND MAUI COUNTY TITLE 19 FOR PERMITTED USES OF AGRICULTURAL LANDS.

PRELIMINARY PLOT PLAN

**MAHANALUA NUI SUB'D.
PHASE IV**

LAUNIUPOKO, LAHAINA, MAUI, HAWAII
 TMK: 2nd Div. 4-7-009:035, 036 & 037
 TMK: 2nd Div. 4-7-010:008, 009 & 010

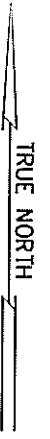
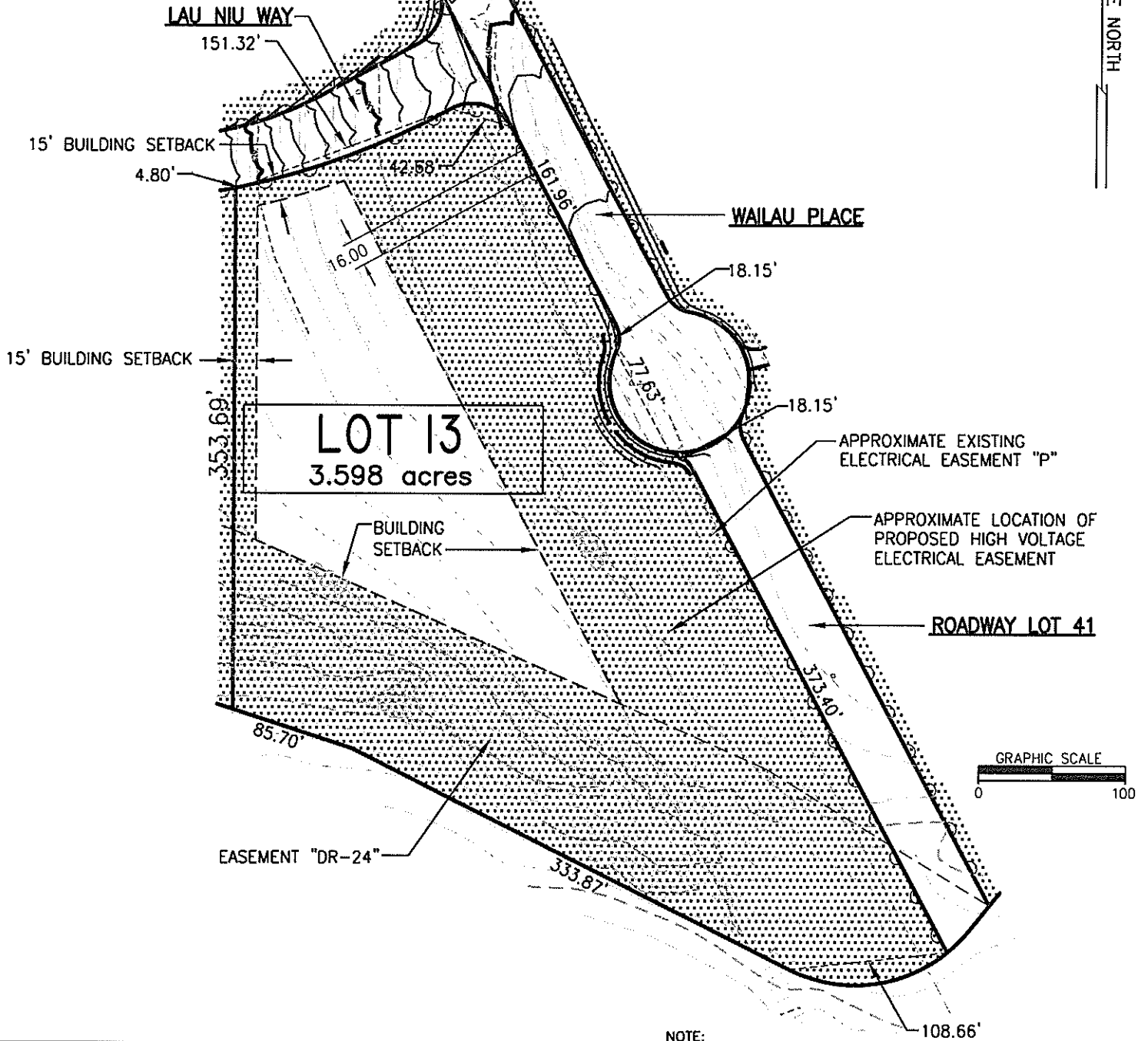

LEGEND	
	ARCH. BUFFER/ STREAMBED PARK
	SETBACK/EASEMENT
	100 YEAR FLOOD INUNDATION LIMITS
	NO ACCESS PERMITTED
	ACCESS PERMITTED

- NOTE:
- ELEVATIONS DERIVED FROM CONSTRUCTION PLANS AND AERIAL TOPOGRAPHIC MAP. TOPOGRAPHIC CONTOURS ARE APPROXIMATE.
 - ALL OWNERS ARE REQUIRED TO RETAIN ALL STORMWATER RUNOFF GENERATED BY IMPROVEMENTS TO THE PROPERTY. NO ADDITIONAL OR ALTERED FLOW IS PERMITTED ON NEIGHBOR PARCELS.
 - MAXIMUM ROOF ELEVATION AND BUILDING SETBACKS ARE DETERMINED BY MAUI COUNTY CODE.
 - THIS IS AN AGRICULTURALLY DESIGNATED AND ZONED PROPERTY. CONSULT HRS 205-4.5 AND MAUI COUNTY TITLE 19 FOR PERMITTED USES OF AGRICULTURAL LANDS.

PRELIMINARY PLOT PLAN

**MAHANALUA NUI SUB'D.
PHASE IV**

LAUNIUPOKO, LAHAINA, MAUI, HAWAII
 TMK: 2nd Div. 4-7-009:035, 036 & 037
 TMK: 2nd Div. 4-7-010:008, 009 & 010

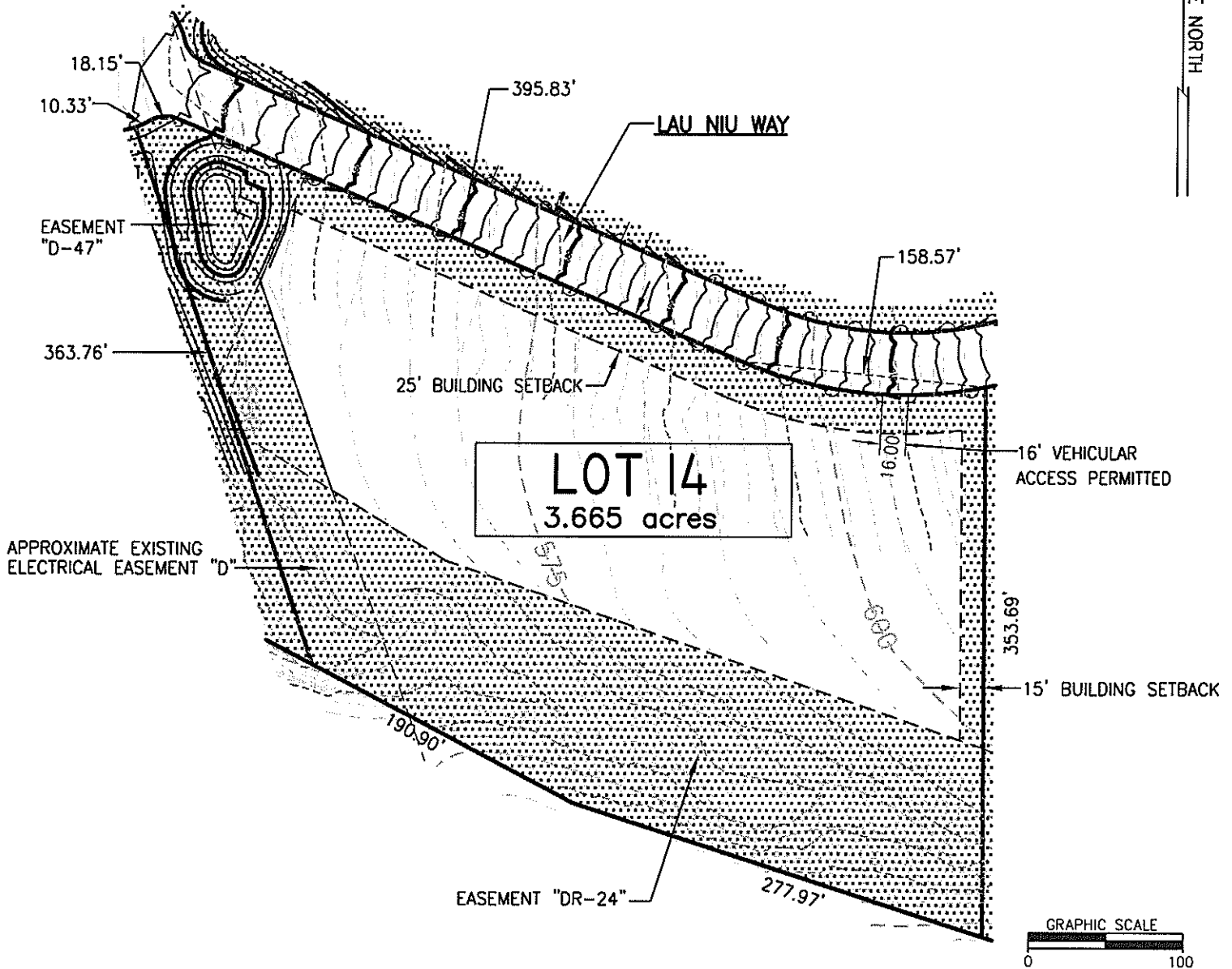

LEGEND	
	ARCH. BUFFER/ STREAMBED PARK
	SETBACK/EASEMENT
	100 YEAR FLOOD INUNDATION LIMITS
	NO ACCESS PERMITTED
	ACCESS PERMITTED

- NOTE:
1. ELEVATIONS DERIVED FROM CONSTRUCTION PLANS AND AERIAL TOPOGRAPHIC MAP. TOPOGRAPHIC CONTOURS ARE APPROXIMATE.
 2. ALL OWNERS ARE REQUIRED TO RETAIN ALL STORMWATER RUNOFF GENERATED BY IMPROVEMENTS TO THE PROPERTY. NO ADDITIONAL OR ALTERED FLOW IS PERMITTED ON NEIGHBOR PARCELS.
 3. MAXIMUM ROOF ELEVATION AND BUILDING SETBACKS ARE DETERMINED BY MAUI COUNTY CODE.
 4. THIS IS AN AGRICULTURALLY DESIGNATED AND ZONED PROPERTY. CONSULT HRS 205-4.5 AND MAUI COUNTY TITLE 19 FOR PERMITTED USES OF AGRICULTURAL LANDS.

PRELIMINARY PLOT PLAN

**MAHANALUA NUI SUB'D.
PHASE IV**

LAUNIUPOKO, LAHAINA, MAUI, HAWAII
 TMK: 2nd Div. 4-7-009:035, 036 & 037
 TMK: 2nd Div. 4-7-010:008, 009 & 010

TRUE NORTH

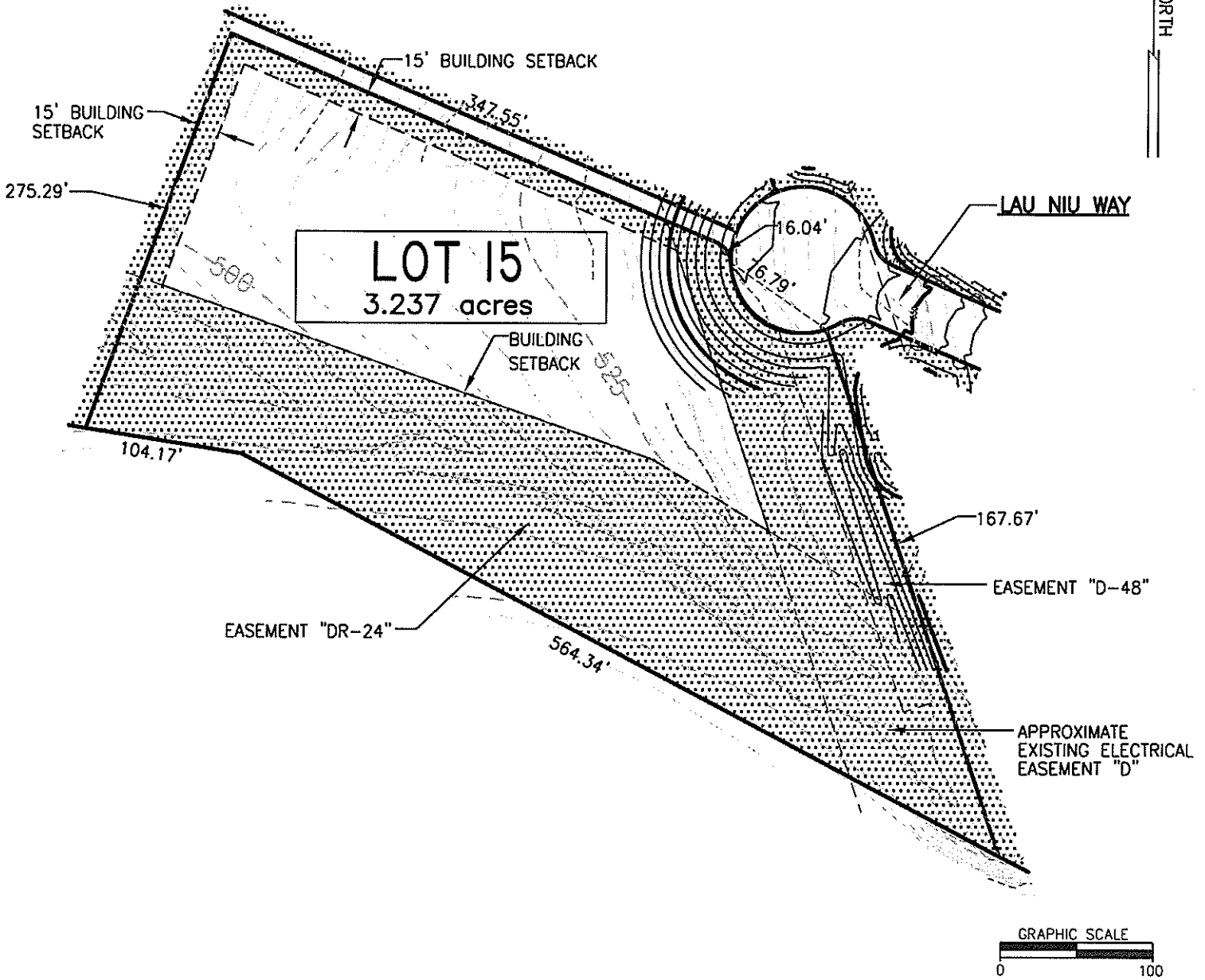

LEGEND	
	ARCH. BUFFER/ STREAMBED PARK
	SETBACK/EASEMENT
	100 YEAR FLOOD INUNDATION LIMITS
	NO ACCESS PERMITTED
	ACCESS PERMITTED

- NOTE:
- ELEVATIONS DERIVED FROM CONSTRUCTION PLANS AND AERIAL TOPOGRAPHIC MAP. TOPOGRAPHIC CONTOURS ARE APPROXIMATE.
 - ALL OWNERS ARE REQUIRED TO RETAIN ALL STORMWATER RUNOFF GENERATED BY IMPROVEMENTS TO THE PROPERTY. NO ADDITIONAL OR ALTERED FLOW IS PERMITTED ON NEIGHBOR PARCELS.
 - MAXIMUM ROOF ELEVATION AND BUILDING SETBACKS ARE DETERMINED BY MAUI COUNTY CODE.
 - THIS IS AN AGRICULTURALLY DESIGNATED AND ZONED PROPERTY. CONSULT HRS 205-4.5 AND MAUI COUNTY TITLE 19 FOR PERMITTED USES OF AGRICULTURAL LANDS.

PRELIMINARY PLOT PLAN

**MAHANALUA NUI SUB'D.
PHASE IV**

LAUNIUPOKO, LAHAINA, MAUI, HAWAII
 TMK: 2nd Div. 4-7-009:035, 036 & 037
 TMK: 2nd Div. 4-7-010:008, 009 & 010

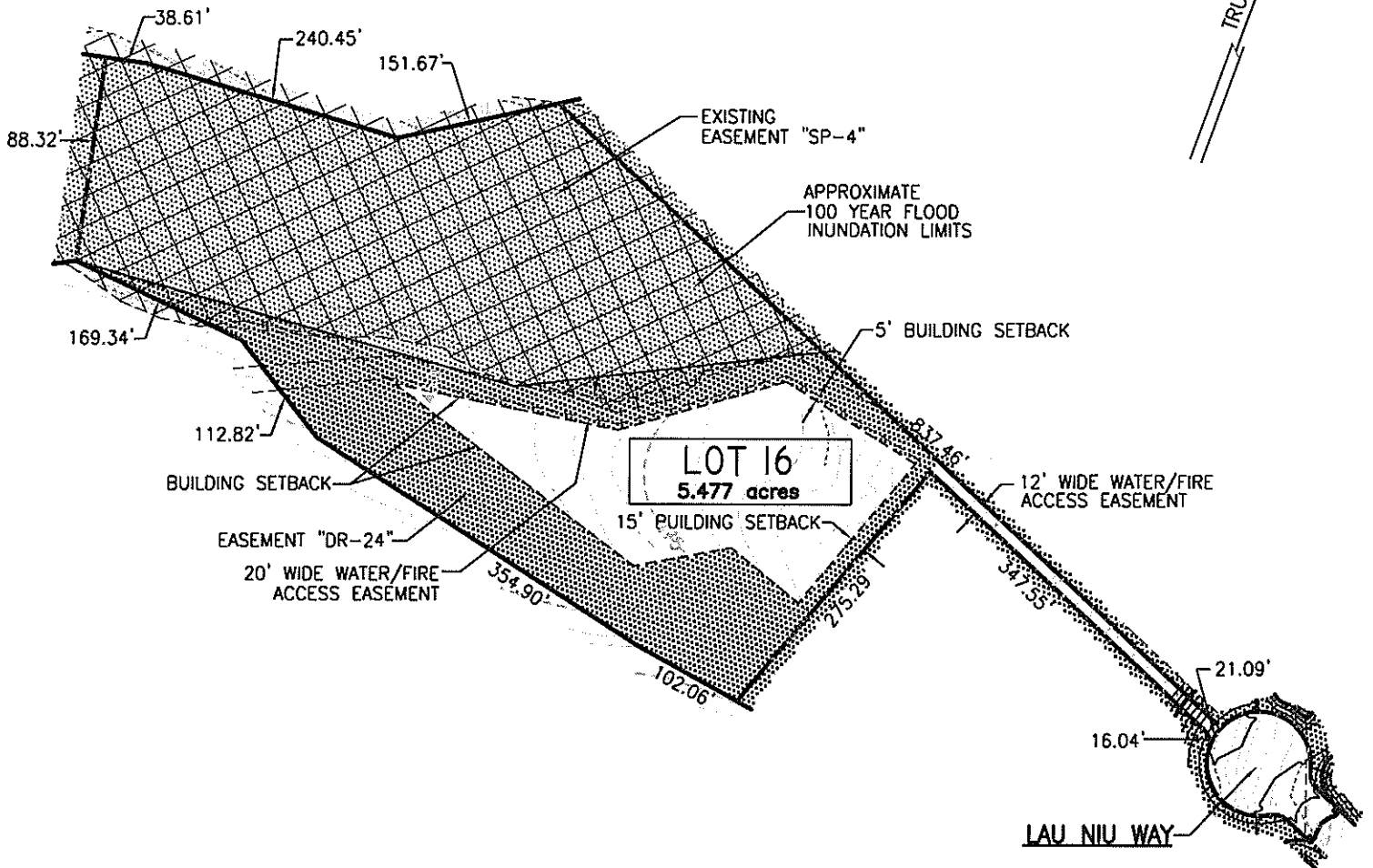

LEGEND	
	ARCH. BUFFER/ STREAMBED PARK
	SETBACK/EASEMENT
	100 YEAR FLOOD INUNDATION LIMITS
	NO ACCESS PERMITTED
	ACCESS PERMITTED

- NOTE:
- ELEVATIONS DERIVED FROM CONSTRUCTION PLANS AND AERIAL TOPOGRAPHIC MAP. TOPOGRAPHIC CONTOURS ARE APPROXIMATE.
 - ALL OWNERS ARE REQUIRED TO RETAIN ALL STORMWATER RUNOFF GENERATED BY IMPROVEMENTS TO THE PROPERTY. NO ADDITIONAL OR ALTERED FLOW IS PERMITTED ON NEIGHBOR PARCELS.
 - MAXIMUM ROOF ELEVATION AND BUILDING SETBACKS ARE DETERMINED BY MAUI COUNTY CODE.
 - THIS IS AN AGRICULTURALLY DESIGNATED AND ZONED PROPERTY. CONSULT HRS 205-4.5 AND MAUI COUNTY TITLE 19 FOR PERMITTED USES OF AGRICULTURAL LANDS.

PRELIMINARY PLOT PLAN

**MAHANALUA NUI SUB'D.
PHASE IV**

LAUNIUPOKO, LAHAINA, MAUI, HAWAII
 TMK: 2nd Div. 4-7-009:035, 036 & 037
 TMK: 2nd Div. 4-7-010:008, 009 & 010

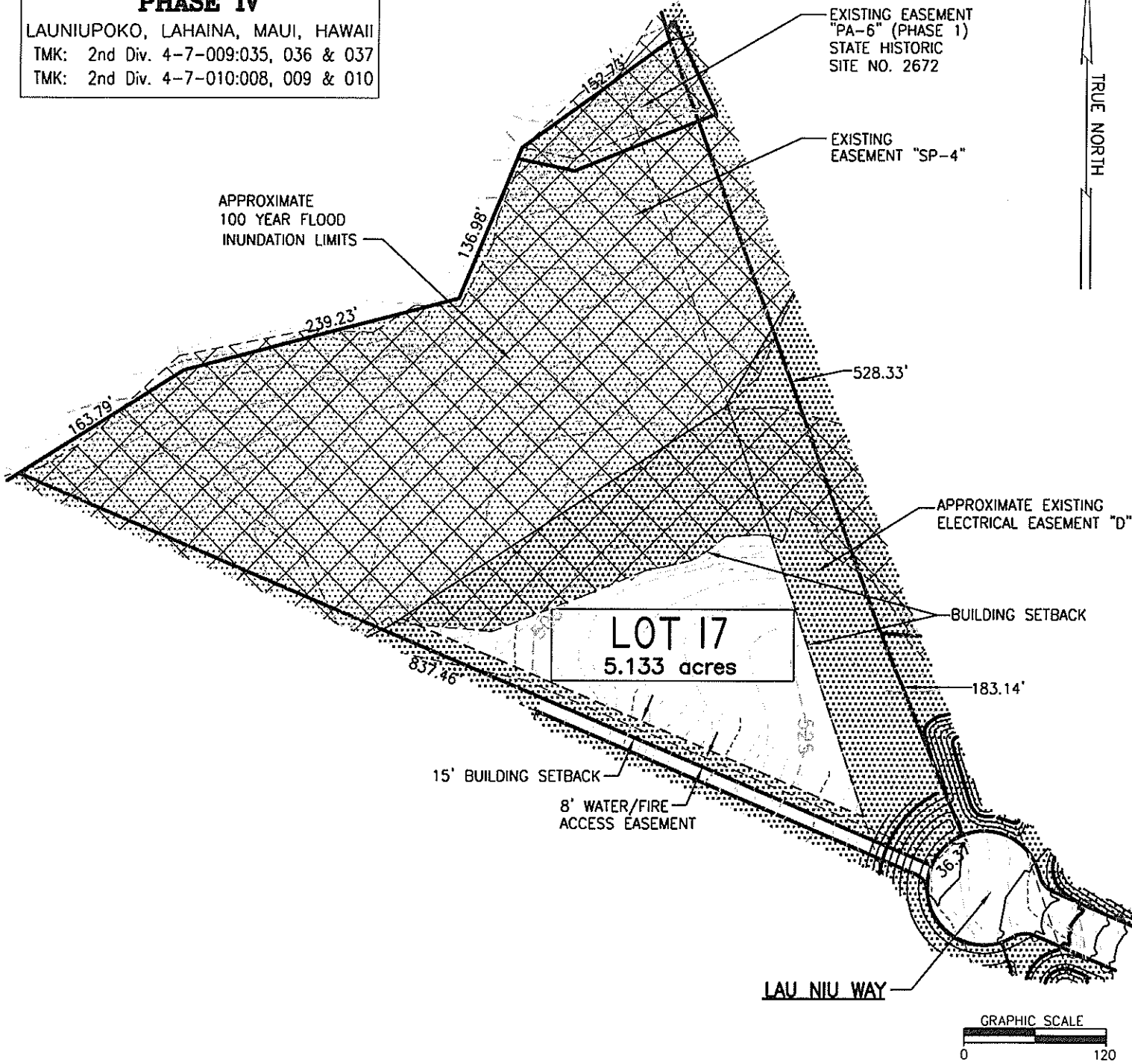

LOT 17
5.133 acres

LEGEND	
	ARCH. BUFFER/ STREAMBED PARK
	SETBACK/EASEMENT
	100 YEAR FLOOD INUNDATION LIMITS
	NO ACCESS PERMITTED
	ACCESS PERMITTED

- NOTE:
1. ELEVATIONS DERIVED FROM CONSTRUCTION PLANS AND AERIAL TOPOGRAPHIC MAP. TOPOGRAPHIC CONTOURS ARE APPROXIMATE.
 2. ALL OWNERS ARE REQUIRED TO RETAIN ALL STORMWATER RUNOFF GENERATED BY IMPROVEMENTS TO THE PROPERTY. NO ADDITIONAL OR ALTERED FLOW IS PERMITTED ON NEIGHBOR PARCELS.
 3. MAXIMUM ROOF ELEVATION AND BUILDING SETBACKS ARE DETERMINED BY MAUI COUNTY CODE.
 4. THIS IS AN AGRICULTURALLY DESIGNATED AND ZONED PROPERTY. CONSULT HRS 205-4.5 AND MAUI COUNTY TITLE 1 FOR PERMITTED USES OF AGRICULTURAL LANDS.

PRELIMINARY PLOT PLAN

**MAHANALUA NUI SUB'D.
PHASE IV**

LAUNIUPOKO, LAHAINA, MAUI, HAWAII
 TMK: 2nd Div. 4-7-009:035, 036 & 037
 TMK: 2nd Div. 4-7-010:008, 009 & 010

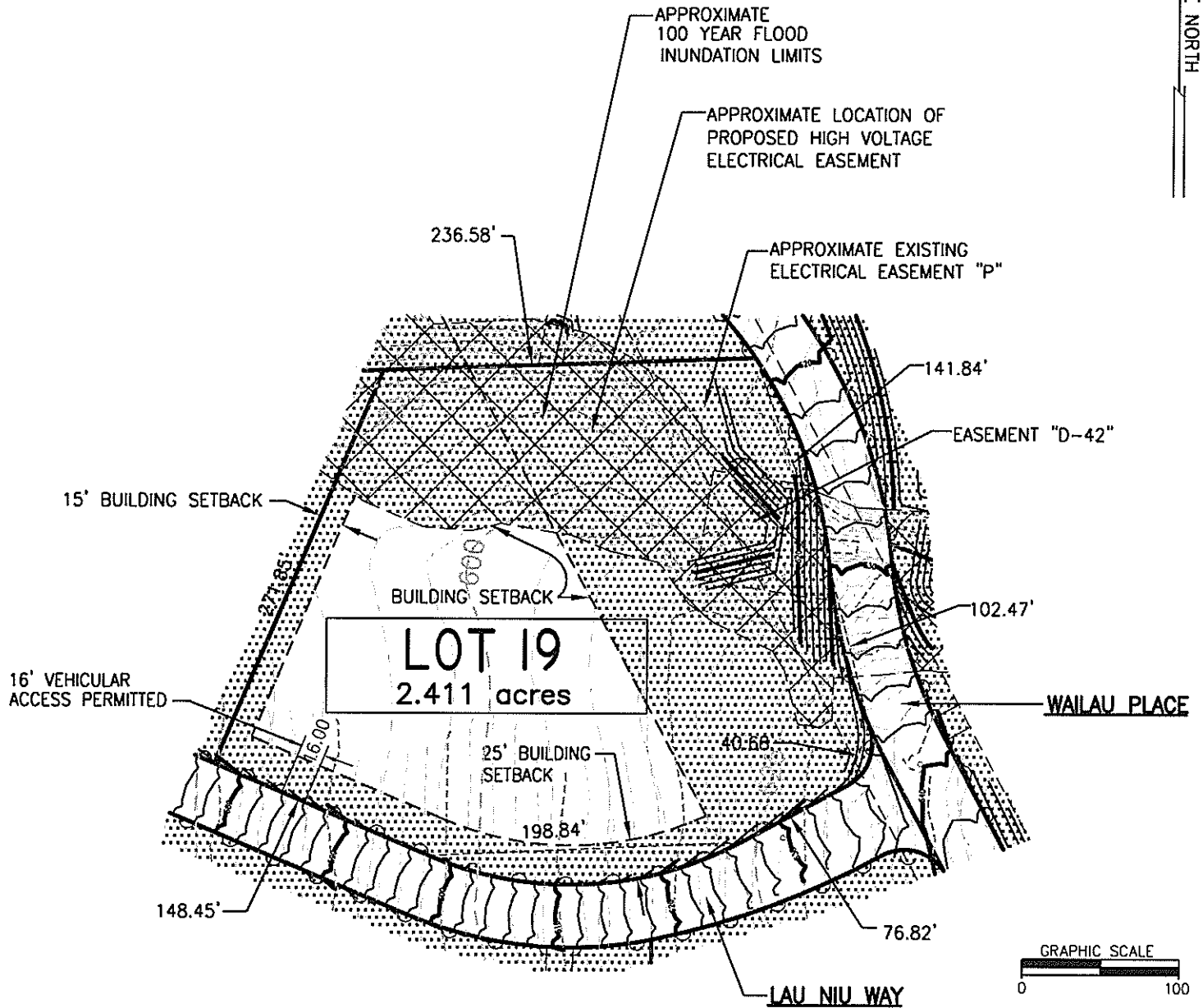

LEGEND	
	ARCH. BUFFER/ STREAMBED PARK
	SETBACK/EASEMENT
	100 YEAR FLOOD INUNDATION LIMITS
	NO ACCESS PERMITTED
	ACCESS PERMITTED

- NOTE:
- ELEVATIONS DERIVED FROM CONSTRUCTION PLANS AND AERIAL TOPOGRAPHIC MAP. TOPOGRAPHIC CONTOURS ARE APPROXIMATE.
 - ALL OWNERS ARE REQUIRED TO RETAIN ALL STORMWATER RUNOFF GENERATED BY IMPROVEMENTS TO THE PROPERTY. NO ADDITIONAL OR ALTERED FLOW IS PERMITTED ON NEIGHBOR PARCELS.
 - MAXIMUM ROOF ELEVATION AND BUILDING SETBACKS ARE DETERMINED BY MAUI COUNTY CODE.
 - THIS IS AN AGRICULTURALLY DESIGNATED AND ZONED PROPERTY. CONSULT HRS 205-4.5 AND MAUI COUNTY TITLE 19 FOR PERMITTED USES OF AGRICULTURAL LANDS.

PRELIMINARY PLOT PLAN

**MAHANALUA NUI SUB'D.
PHASE IV**

LAUNIUPOKO, LAHAINA, MAUI, HAWAII
 TMK: 2nd Div. 4-7-009:035, 036 & 037
 TMK: 2nd Div. 4-7-010:008, 009 & 010

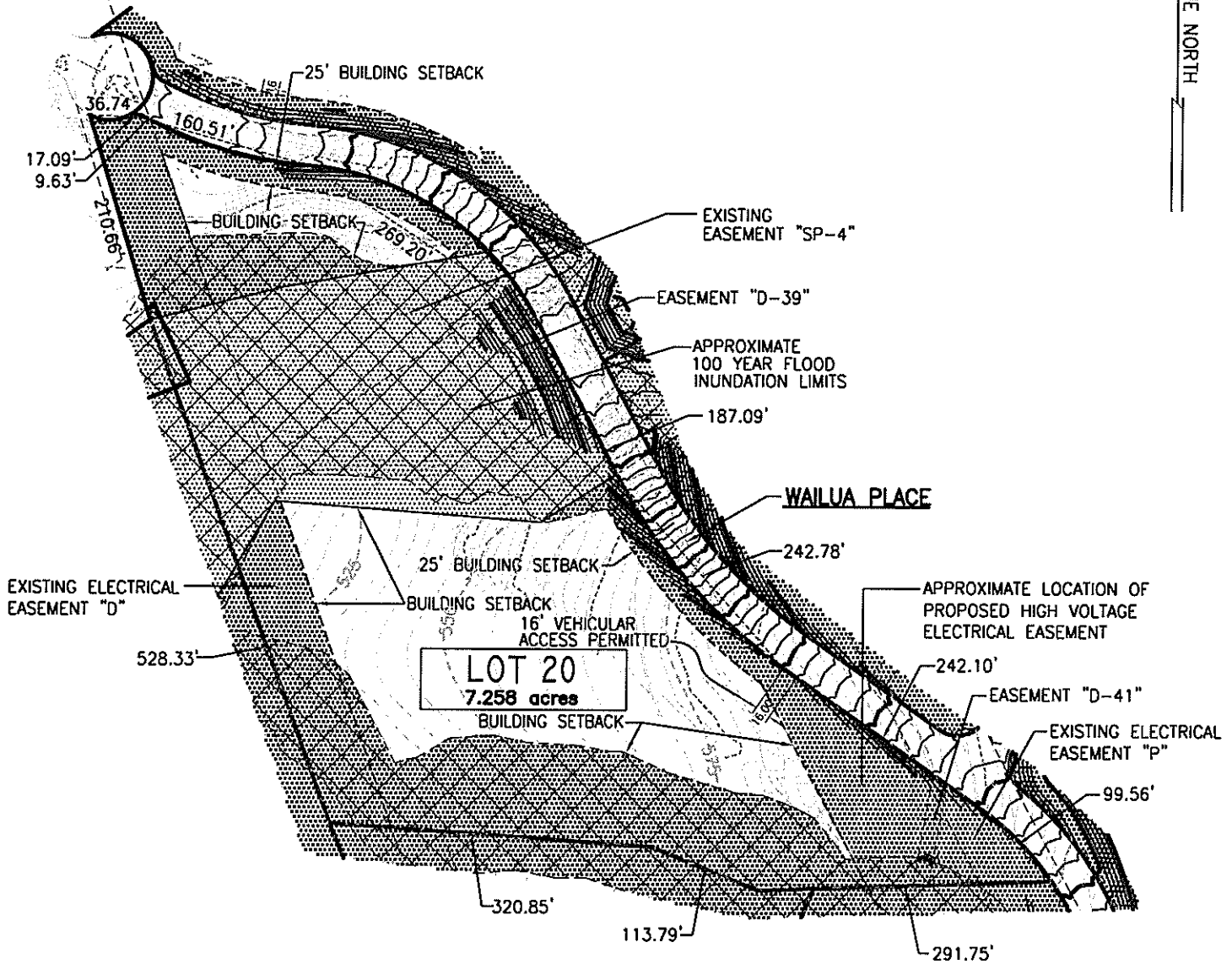

LEGEND	
	ARCH. BUFFER/ STREAMBED PARK
	SETBACK/EASEMENT
	100 YEAR FLOOD INUNDATION LIMITS
	NO ACCESS PERMITTED
	ACCESS PERMITTED

- NOTE:
- ELEVATIONS DERIVED FROM CONSTRUCTION PLANS AND AERIAL TOPOGRAPHIC MAP. TOPOGRAPHIC CONTOURS ARE APPROXIMATE.
 - ALL OWNERS ARE REQUIRED TO RETAIN ALL STORMWATER RUNOFF GENERATED BY IMPROVEMENTS TO THE PROPERTY. NO ADDITIONAL OR ALTERED FLOW IS PERMITTED ON NEIGHBOR PARCELS.
 - MAXIMUM ROOF ELEVATION AND BUILDING SETBACKS ARE DETERMINED BY MAUI COUNTY CODE.
 - THIS IS AN AGRICULTURALLY DESIGNATED AND ZONED PROPERTY. CONSULT HRS 205-4.5 AND MAUI COUNTY TITLE 19 FOR PERMITTED USES OF AGRICULTURAL LANDS.

PRELIMINARY PLOT PLAN

**MAHANALUA NUI SUB'D.
PHASE IV**

LAUNIUPOKO, LAHAINA, MAUI, HAWAII
 TMK: 2nd Div. 4-7-009:035, 036 & 037
 TMK: 2nd Div. 4-7-010:008, 009 & 010

TRUE NORTH

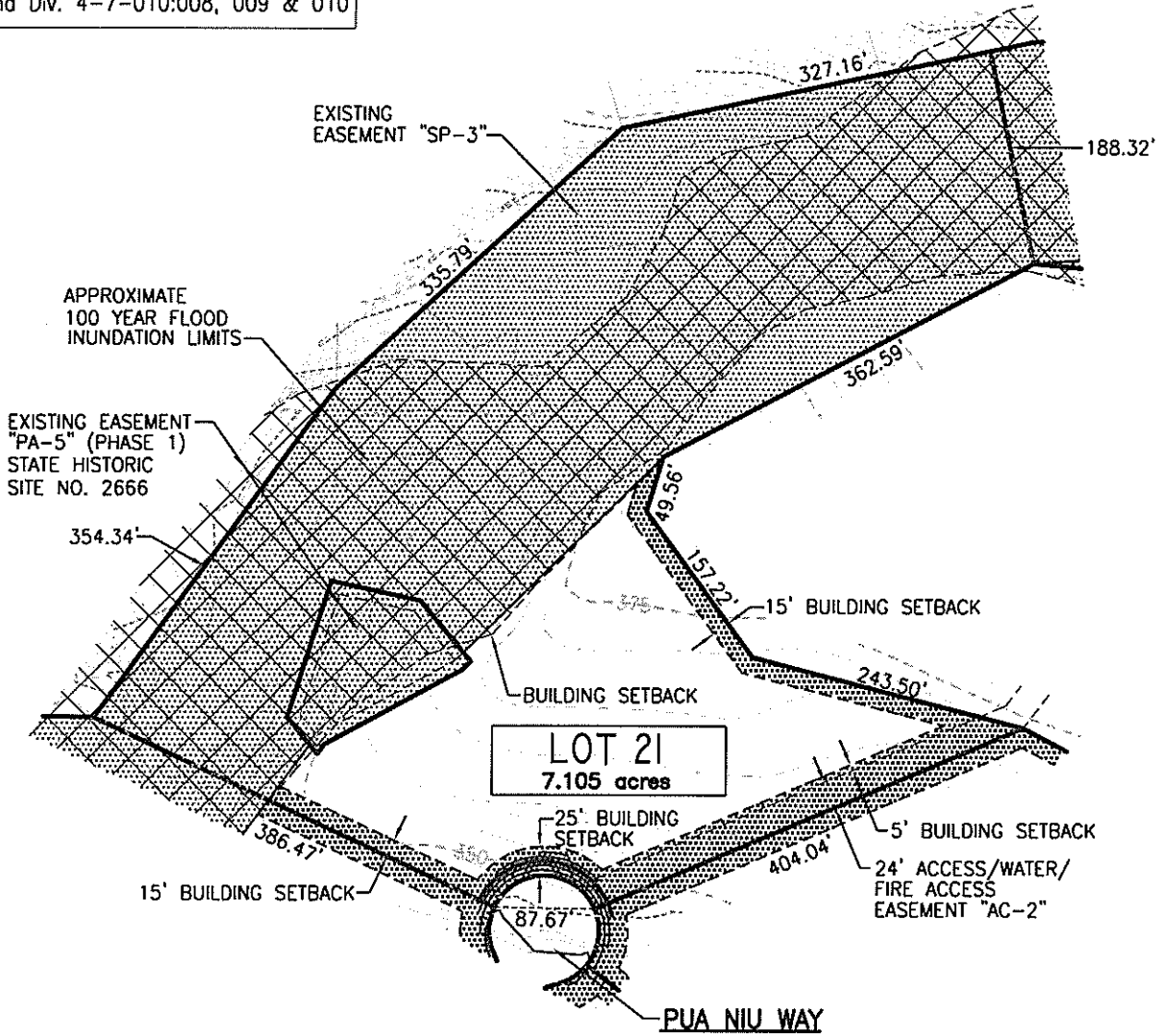

LOT 21
7.105 acres



LEGEND	
	ARCH. BUFFER/ STREAMBED PARK
	SETBACK/EASEMENT
	100 YEAR FLOOD INUNDATION LIMITS
	NO ACCESS PERMITTED
	ACCESS PERMITTED

- NOTE:
- ELEVATIONS DERIVED FROM CONSTRUCTION PLANS AND AERIAL TOPOGRAPHIC MAP. TOPOGRAPHIC CONTOURS ARE APPROXIMATE.
 - ALL OWNERS ARE REQUIRED TO RETAIN ALL STORMWATER RUNOFF GENERATED BY IMPROVEMENTS TO THE PROPERTY. NO ADDITIONAL OR ALTERED FLOW IS PERMITTED ON NEIGHBOR PARCELS.
 - MAXIMUM ROOF ELEVATION AND BUILDING SETBACKS ARE DETERMINED BY MAUI COUNTY CODE.
 - THIS IS AN AGRICULTURALLY DESIGNATED AND ZONED PROPERTY. CONSULT HRS 205-4.5 AND MAUI COUNTY TITLE 19 FOR PERMITTED USES OF AGRICULTURAL LANDS.

PRELIMINARY PLOT PLAN

**MAHANALUA NUI SUB'D.
PHASE IV**

LAUNIUPOKO, LAHAINA, MAUI, HAWAII
 TMK: 2nd Div. 4-7-009:035, 036 & 037
 TMK: 2nd Div. 4-7-010:008, 009 & 010

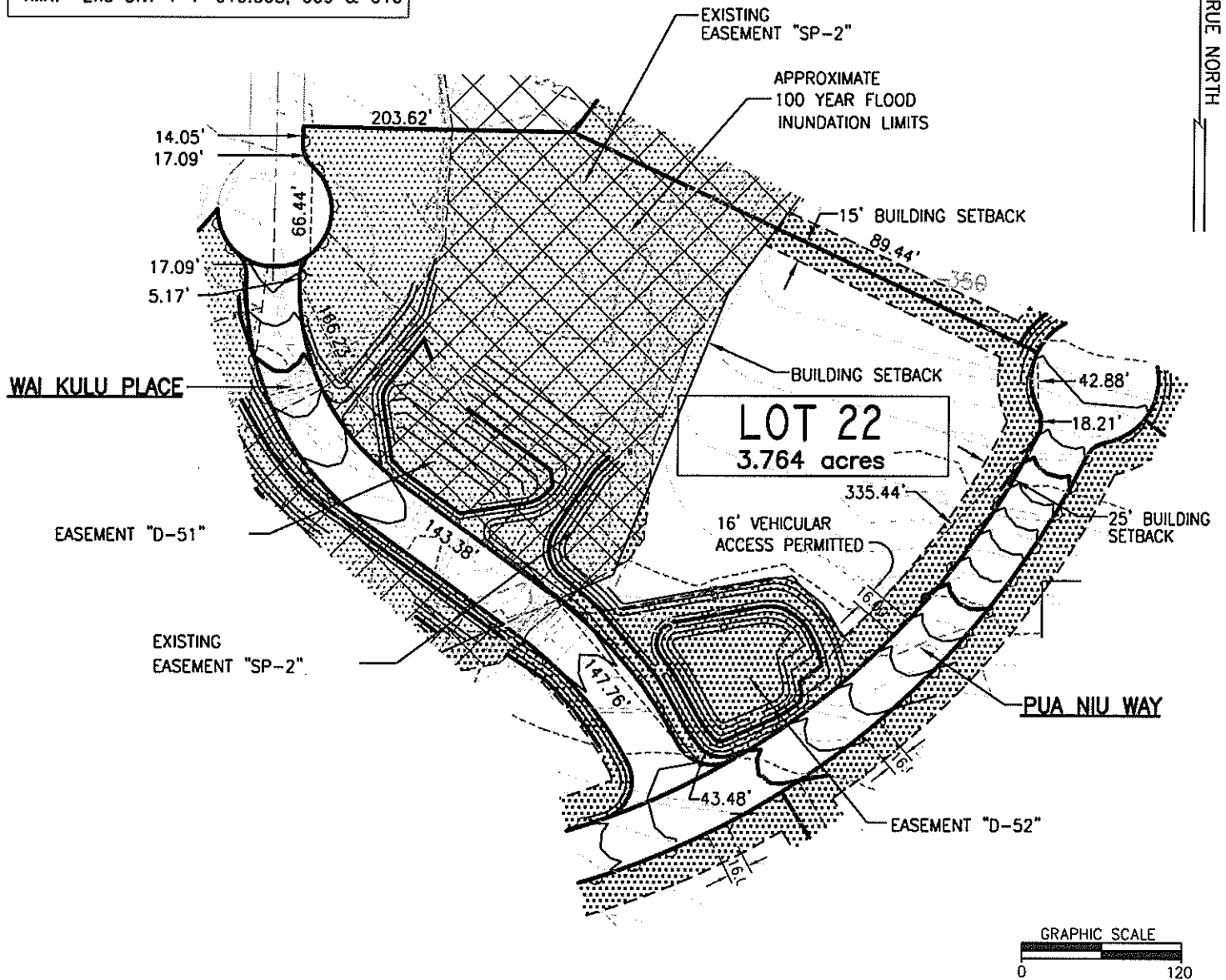

LEGEND	
	ARCH. BUFFER/ STREAMBED PARK
	SETBACK/EASEMENT
	100 YEAR FLOOD INUNDATION LIMITS
	NO ACCESS PERMITTED
	ACCESS PERMITTED

- NOTE:
- ELEVATIONS DERIVED FROM CONSTRUCTION PLANS AND AERIAL TOPOGRAPHIC MAP. TOPOGRAPHIC CONTOURS ARE APPROXIMATE.
 - ALL OWNERS ARE REQUIRED TO RETAIN ALL STORMWATER RUNOFF GENERATED BY IMPROVEMENTS TO THE PROPERTY. NO ADDITIONAL OR ALTERED FLOW IS PERMITTED ON NEIGHBOR PARCELS.
 - MAXIMUM ROOF ELEVATION AND BUILDING SETBACKS ARE DETERMINED BY MAUI COUNTY CODE.
 - THIS IS AN AGRICULTURALLY DESIGNATED AND ZONED PROPERTY. CONSULT HRS 205-4.5 AND MAUI COUNTY TITLE 19 FOR PERMITTED USES OF AGRICULTURAL LANDS.

PRELIMINARY PLOT PLAN

**MAHANALUA NUI SUB'D.
PHASE IV**

LAUNIUPOKO, LAHAINA, MAUI, HAWAII
 TMK: 2nd Div. 4-7-009:035, 036 & 037
 TMK: 2nd Div. 4-7-010:008, 009 & 010

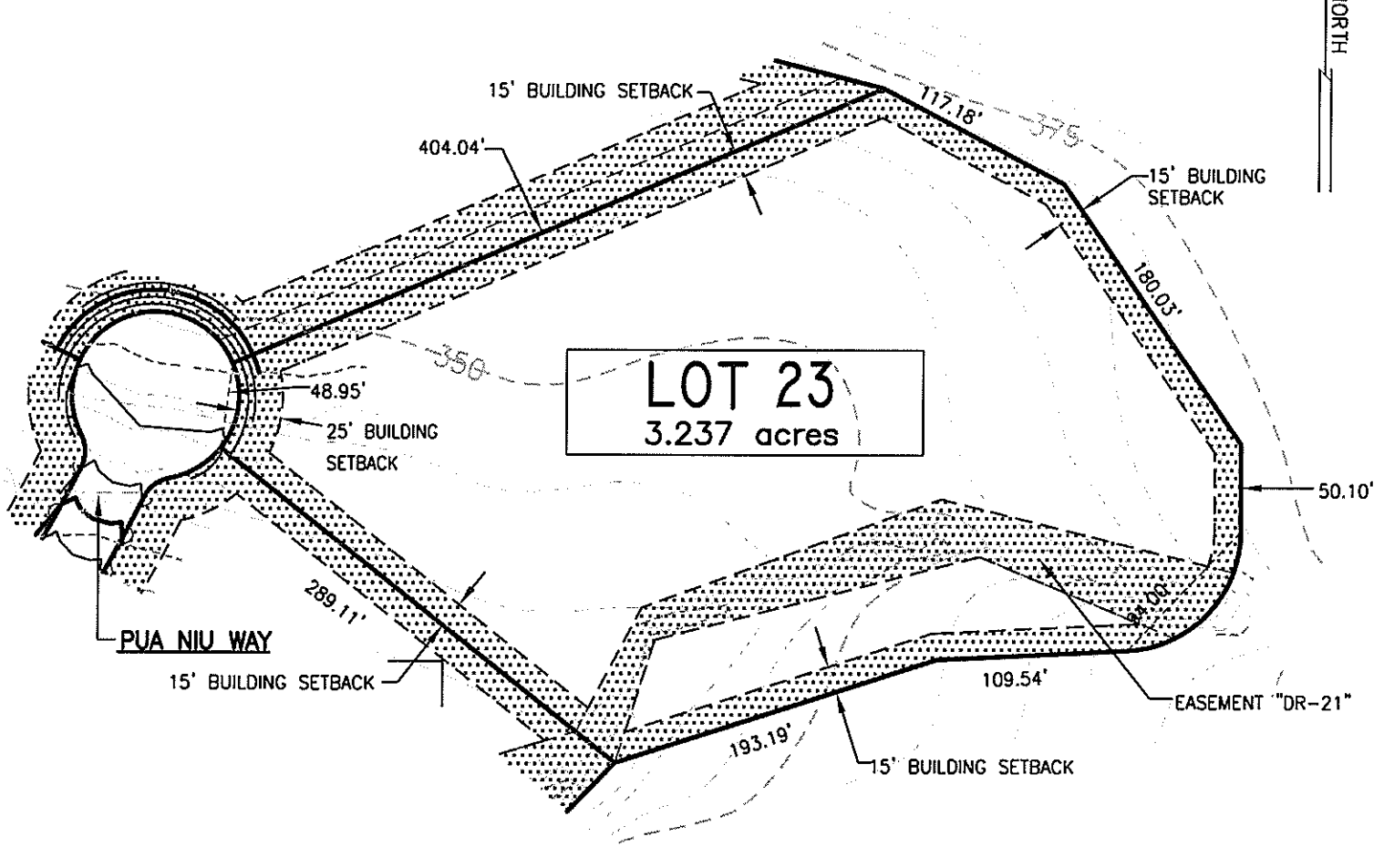
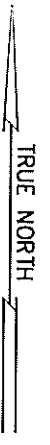

- NOTE:**
1. ELEVATIONS DERIVED FROM CONSTRUCTION PLANS AND AERIAL TOPOGRAPHIC MAP. TOPOGRAPHIC CONTOURS ARE APPROXIMATE.
 2. ALL OWNERS ARE REQUIRED TO RETAIN ALL STORMWATER RUNOFF GENERATED BY IMPROVEMENTS TO THE PROPERTY. NO ADDITIONAL OR ALTERED FLOW IS PERMITTED ON NEIGHBOR PARCELS.
 3. MAXIMUM ROOF ELEVATION AND BUILDING SETBACKS ARE DETERMINED BY MAUI COUNTY CODE.
 4. THIS IS AN AGRICULTURALLY DESIGNATED AND ZONED PROPERTY. CONSULT HRS 205-4.5 AND MAUI COUNTY TITLE 19 FOR PERMITTED USES OF AGRICULTURAL LANDS.

LEGEND	
	ARCH. BUFFER/ STREAMBED PARK
	SETBACK/EASEMENT
	100 YEAR FLOOD INUNDATION LIMITS
	NO ACCESS PERMITTED
	ACCESS PERMITTED

PRELIMINARY PLOT PLAN

**MAHANALUA NUI SUB'D.
PHASE IV**

LAUNIUPOKO, LAHAINA, MAUI, HAWAII
 TMK: 2nd Div. 4-7-009:035, 036 & 037
 TMK: 2nd Div. 4-7-010:008, 009 & 010

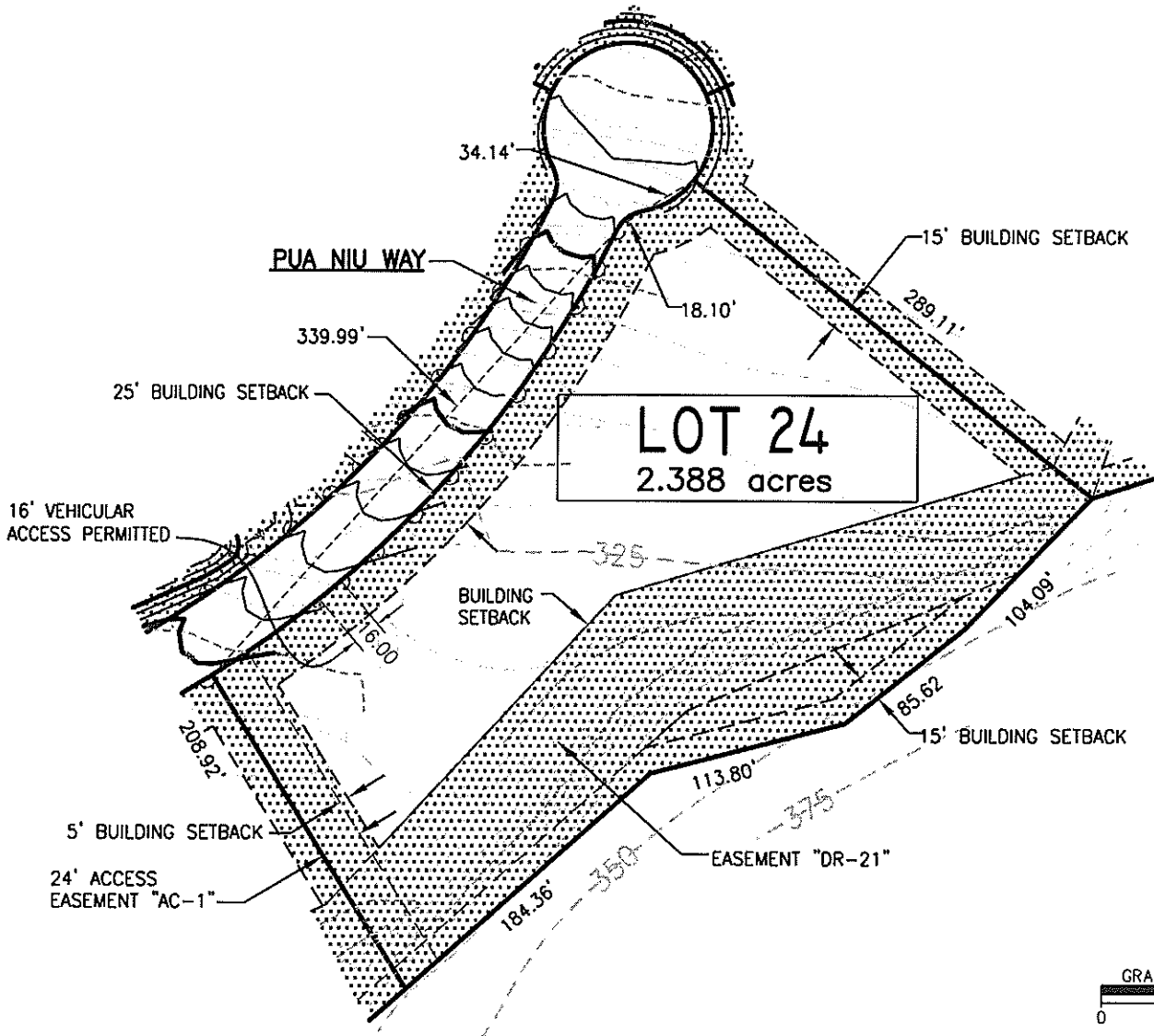
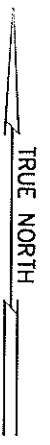

LEGEND	
	ARCH. BUFFER/ STREAMBED PARK
	SETBACK/EASEMENT
	100 YEAR FLOOD INUNDATION LIMITS
	NO ACCESS PERMITTED
	ACCESS PERMITTED

NOTE:

1. ELEVATIONS DERIVED FROM CONSTRUCTION PLANS AND AERIAL TOPOGRAPHIC MAP. TOPOGRAPHIC CONTOURS ARE APPROXIMATE.
2. ALL OWNERS ARE REQUIRED TO RETAIN ALL STORMWATER RUNOFF GENERATED BY IMPROVEMENTS TO THE PROPERTY. NO ADDITIONAL OR ALTERED FLOW IS PERMITTED ON NEIGHBOR PARCELS.
3. MAXIMUM ROOF ELEVATION AND BUILDING SETBACKS ARE DETERMINED BY MAUI COUNTY CODE.
4. THIS IS AN AGRICULTURALLY DESIGNATED AND ZONED PROPERTY. CONSULT HRS 205-4.5 AND MAUI COUNTY TITLE 19 FOR PERMITTED USES OF AGRICULTURAL LANDS.

PRELIMINARY PLOT PLAN

**MAHANALUA NUI SUB'D.
PHASE IV**

LAUNIUPOKO, LAHAINA, MAUI, HAWAII
 TMK: 2nd Div. 4-7-009:035, 036 & 037
 TMK: 2nd Div. 4-7-010:008, 009 & 010

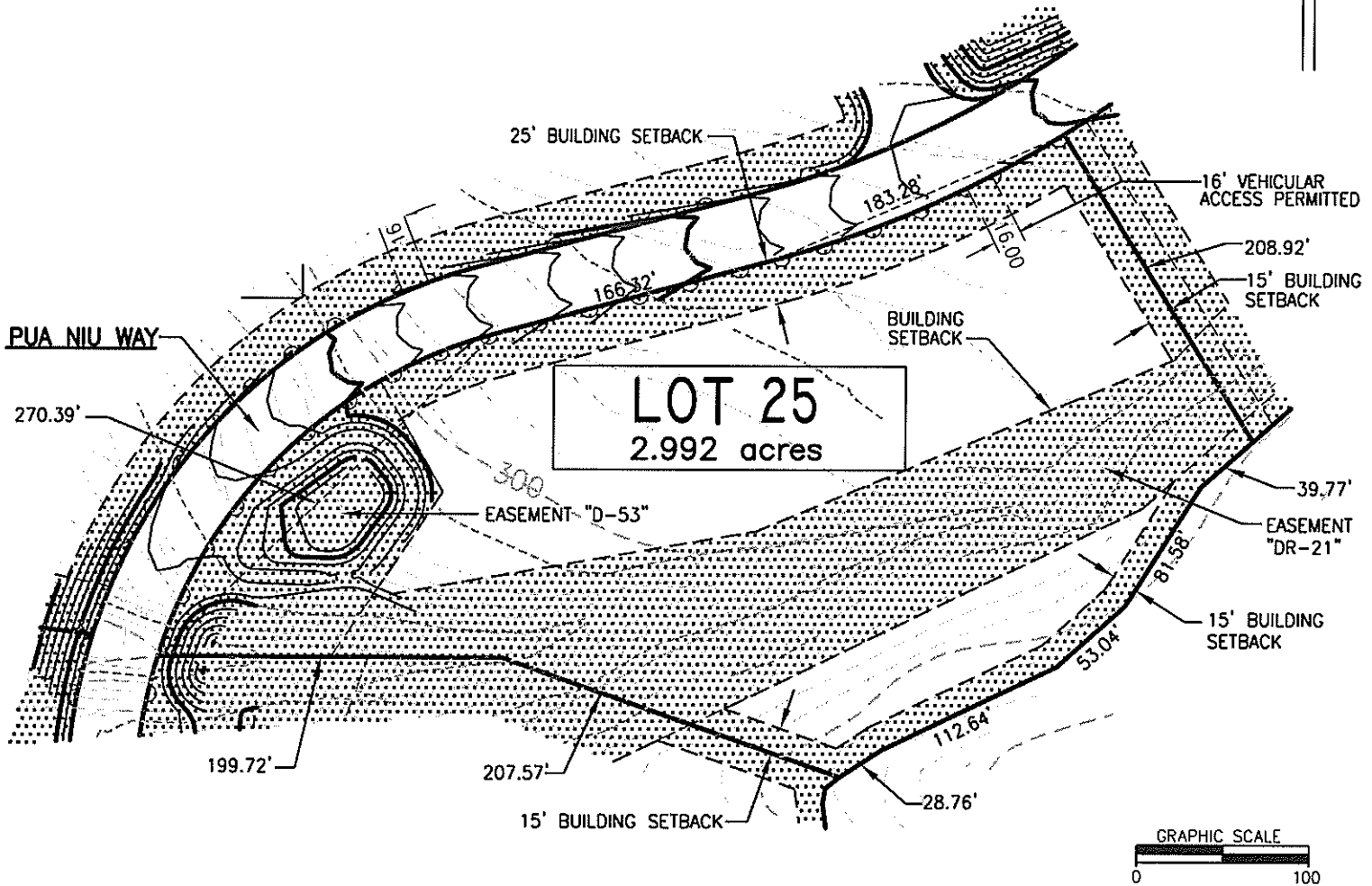

- NOTE:**
1. ELEVATIONS DERIVED FROM CONSTRUCTION PLANS AND AERIAL TOPOGRAPHIC MAP. TOPOGRAPHIC CONTOURS ARE APPROXIMATE.
 2. ALL OWNERS ARE REQUIRED TO RETAIN ALL STORMWATER RUNOFF GENERATED BY IMPROVEMENTS TO THE PROPERTY. NO ADDITIONAL OR ALTERED FLOW IS PERMITTED ON NEIGHBOR PARCELS.
 3. MAXIMUM ROOF ELEVATION AND BUILDING SETBACKS ARE DETERMINED BY MAUI COUNTY CODE.
 4. THIS IS AN AGRICULTURALLY DESIGNATED AND ZONED PROPERTY. CONSULT HRS 205-4.5 AND MAUI COUNTY TITLE 19 FOR PERMITTED USES OF AGRICULTURAL LANDS.

LEGEND	
	ARCH. BUFFER/ STREAMBED PARK
	SETBACK/EASEMENT
	100 YEAR FLOOD INUNDATION LIMITS
	NO ACCESS PERMITTED
	ACCESS PERMITTED

PRELIMINARY PLOT PLAN

**MAHANALUA NUI SUB'D.
PHASE IV**

LAUNIUPOKO, LAHAINA, MAUI, HAWAII
 TMK: 2nd Div. 4-7-009:035, 036 & 037
 TMK: 2nd Div. 4-7-010:008, 009 & 010

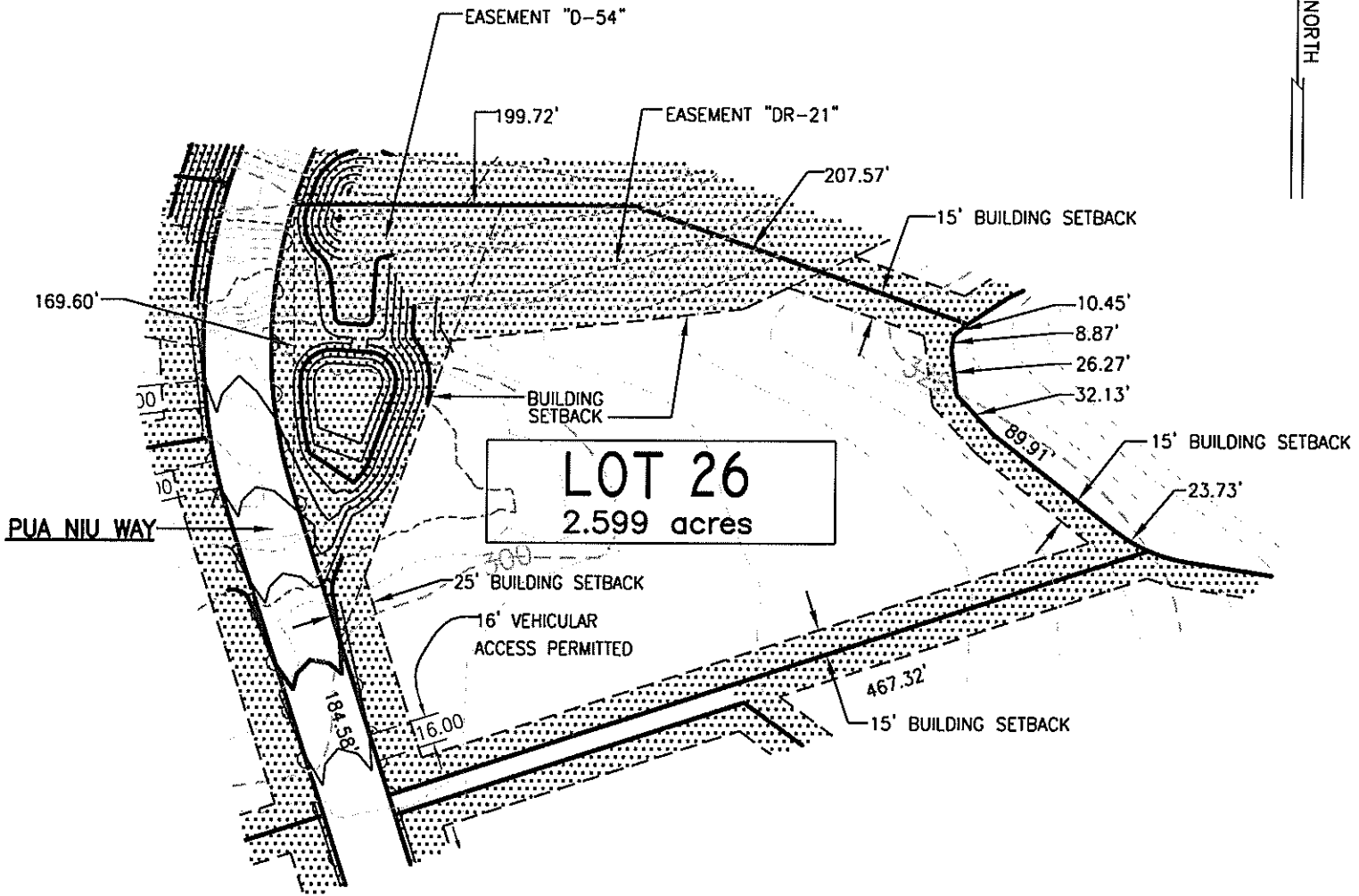

LOT 26
2.599 acres



- NOTE:
1. ELEVATIONS DERIVED FROM CONSTRUCTION PLANS AND AERIAL TOPOGRAPHIC MAP. TOPOGRAPHIC CONTOURS ARE APPROXIMATE.
 2. ALL OWNERS ARE REQUIRED TO RETAIN ALL STORMWATER RUNOFF GENERATED BY IMPROVEMENTS TO THE PROPERTY. NO ADDITIONAL OR ALTERED FLOW IS PERMITTED ON NEIGHBOR PARCELS.
 3. MAXIMUM ROOF ELEVATION AND BUILDING SETBACKS ARE DETERMINED BY MAUI COUNTY CODE.
 4. THIS IS AN AGRICULTURALLY DESIGNATED AND ZONED PROPERTY. CONSULT HRS 205-4.5 AND MAUI COUNTY TITLE 19 FOR PERMITTED USES OF AGRICULTURAL LANDS.

LEGEND	
	ARCH. BUFFER/ STREAMBED PARK
	SETBACK/EASEMENT
	100 YEAR FLOOD INUNDATION LIMITS
	NO ACCESS PERMITTED
	ACCESS PERMITTED

PRELIMINARY PLOT PLAN

**MAHANALUA NUI SUB'D.
PHASE IV**

LAUNIUPOKO, LAHAINA, MAUI, HAWAII
 TMK: 2nd Div. 4-7-009:035, 036 & 037
 TMK: 2nd Div. 4-7-010:008, 009 & 010

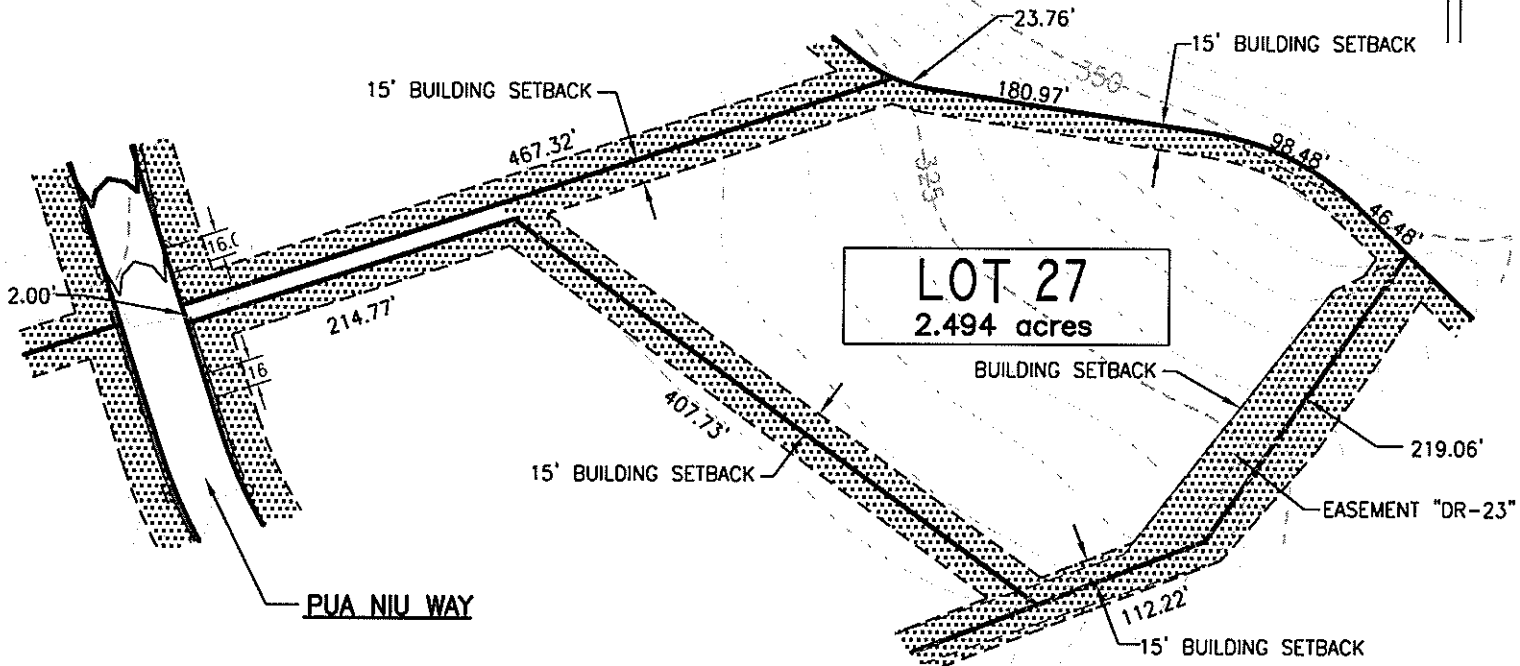

LOT 27
2.494 acres



- NOTE:**
1. ELEVATIONS DERIVED FROM CONSTRUCTION PLANS AND AERIAL TOPOGRAPHIC MAP. TOPOGRAPHIC CONTOURS ARE APPROXIMATE.
 2. ALL OWNERS ARE REQUIRED TO RETAIN ALL STORMWATER RUNOFF GENERATED BY IMPROVEMENTS TO THE PROPERTY. NO ADDITIONAL OR ALTERED FLOW IS PERMITTED ON NEIGHBOR PARCELS.
 3. MAXIMUM ROOF ELEVATION AND BUILDING SETBACKS ARE DETERMINED BY MAUI COUNTY CODE.
 4. THIS IS AN AGRICULTURALLY DESIGNATED AND ZONED PROPERTY. CONSULT HRS 205-4.5 AND MAUI COUNTY TITLE 19 FOR PERMITTED USES OF AGRICULTURAL LANDS.

LEGEND	
	ARCH. BUFFER/ STREAMBED PARK
	SETBACK/EASEMENT
	100 YEAR FLOOD INUNDATION LIMITS
	NO ACCESS PERMITTED
	ACCESS PERMITTED

PRELIMINARY PLOT PLAN

**MAHANALUA NUI SUB'D.
PHASE IV**

LAUNIUPOKO, LAHAINA, MAUI, HAWAII
 TMK: 2nd Div. 4-7-009:035, 036 & 037
 TMK: 2nd Div. 4-7-010:008, 009 & 010

TRUE NORTH

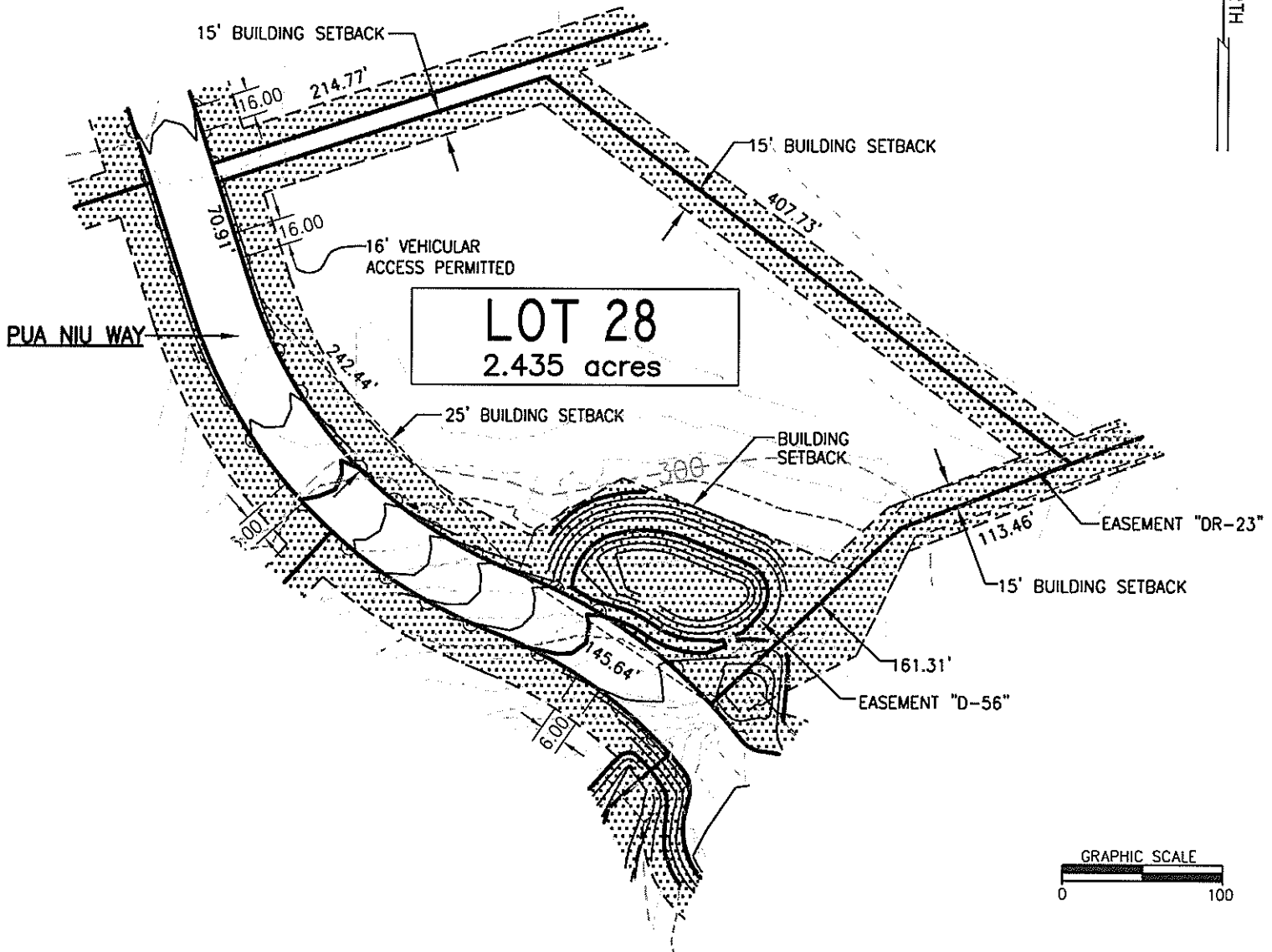

LOT 28
2.435 acres

LEGEND	
	ARCH. BUFFER/ STREAMBED PARK
	SETBACK/EASEMENT
	100 YEAR FLOOD INUNDATION LIMITS
	NO ACCESS PERMITTED
	ACCESS PERMITTED

- NOTE:
- ELEVATIONS DERIVED FROM CONSTRUCTION PLANS AND AERIAL TOPOGRAPHIC MAP. TOPOGRAPHIC CONTOURS ARE APPROXIMATE.
 - ALL OWNERS ARE REQUIRED TO RETAIN ALL STORMWATER RUNOFF GENERATED BY IMPROVEMENTS TO THE PROPERTY. NO ADDITIONAL OR ALTERED FLOW IS PERMITTED ON NEIGHBOR PARCELS.
 - MAXIMUM ROOF ELEVATION AND BUILDING SETBACKS ARE DETERMINED BY MAUI COUNTY CODE.
 - THIS IS AN AGRICULTURALLY DESIGNATED AND ZONED PROPERTY. CONSULT HRS 205-4.5 AND MAUI COUNTY TITLE 19 FOR PERMITTED USES OF AGRICULTURAL LANDS.

PRELIMINARY PLOT PLAN

**MAHANALUA NUI SUB'D.
PHASE IV**

LAUNIUPOKO, LAHAINA, MAUI, HAWAII
 TMK: 2nd Div. 4-7-009:035, 036 & 037
 TMK: 2nd Div. 4-7-010:008, 009 & 010

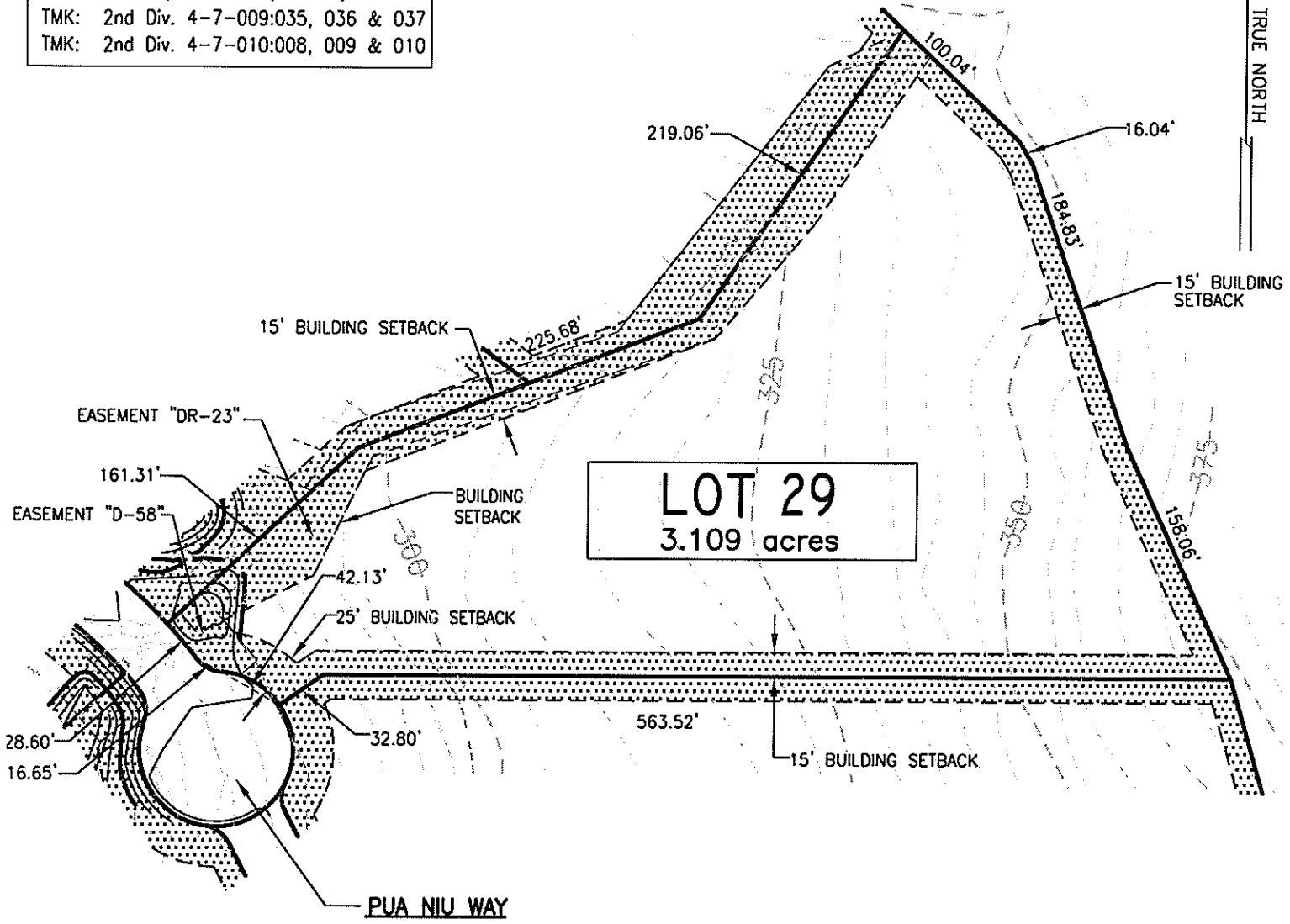

LOT 29
3.109 acres

LEGEND	
	ARCH. BUFFER/ STREAMBED PARK
	SETBACK/EASEMENT
	100 YEAR FLOOD INUNDATION LIMITS
	NO ACCESS PERMITTED
	ACCESS PERMITTED

- NOTE:
- ELEVATIONS DERIVED FROM CONSTRUCTION PLANS AND AERIAL TOPOGRAPHIC MAP. TOPOGRAPHIC CONTOURS ARE APPROXIMATE.
 - ALL OWNERS ARE REQUIRED TO RETAIN ALL STORMWATER RUNOFF GENERATED BY IMPROVEMENTS TO THE PROPERTY. NO ADDITIONAL OR ALTERED FLOW IS PERMITTED ON NEIGHBOR PARCELS.
 - MAXIMUM ROOF ELEVATION AND BUILDING SETBACKS ARE DETERMINED BY MAUI COUNTY CODE.
 - THIS IS AN AGRICULTURALLY DESIGNATED AND ZONED PROPERTY. CONSULT HRS 205-4.5 AND MAUI COUNTY TITLE 19 FOR PERMITTED USES OF AGRICULTURAL LANDS.

PRELIMINARY PLOT PLAN

**MAHANALUA NUI SUB'D.
PHASE IV**

LAUNIUPOKO, LAHAINA, MAUI, HAWAII
 TMK: 2nd Div. 4-7-009:035, 036 & 037
 TMK: 2nd Div. 4-7-010:008, 009 & 010

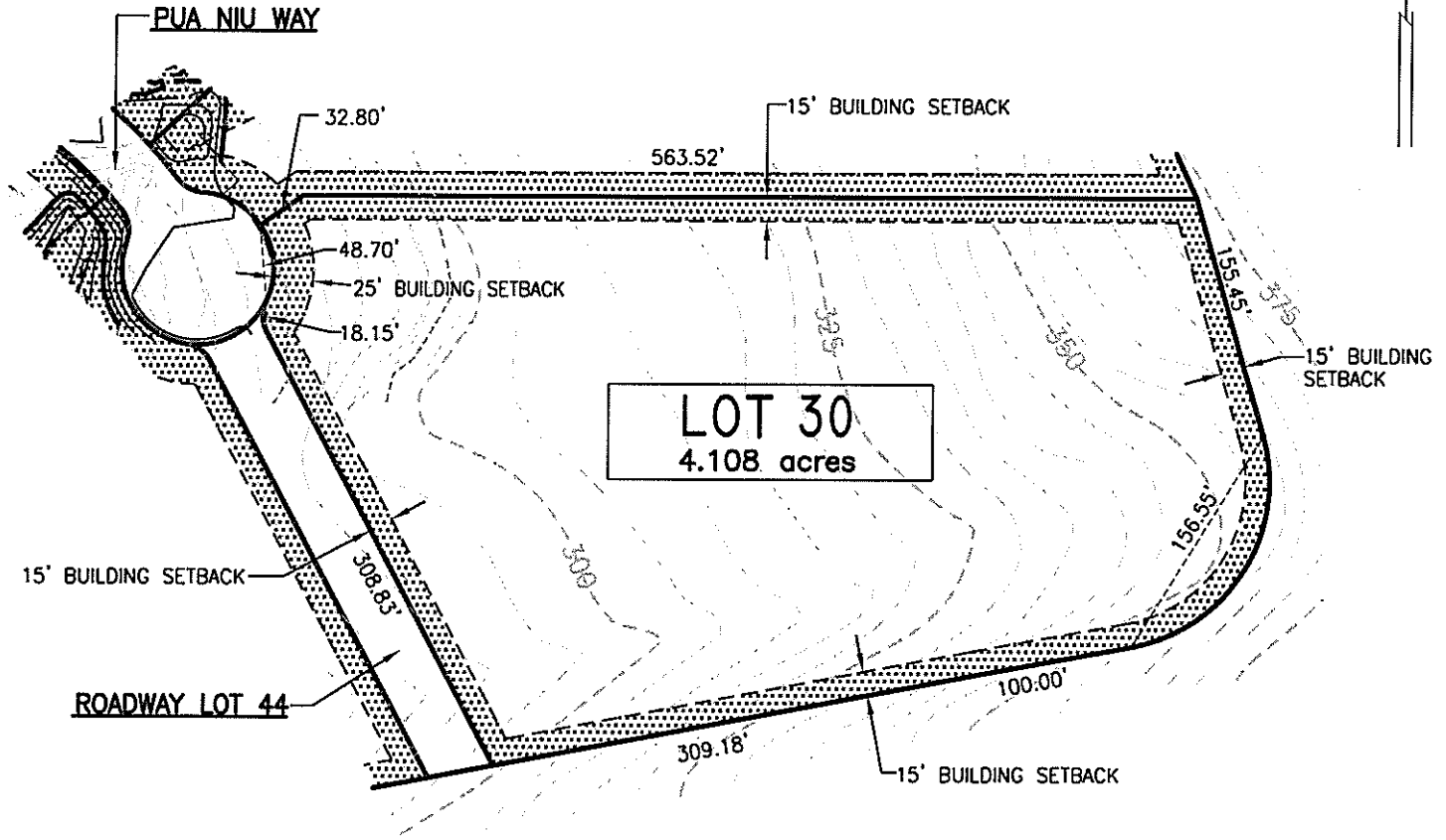
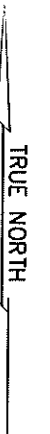

LOT 30
4.108 acres



LEGEND	
	ARCH. BUFFER/ STREAMBED PARK
	SETBACK/EASEMENT
	100 YEAR FLOOD INUNDATION LIMITS
	NO ACCESS PERMITTED
	ACCESS PERMITTED

- NOTE:**
- ELEVATIONS DERIVED FROM CONSTRUCTION PLANS AND AERIAL TOPOGRAPHIC MAP. TOPOGRAPHIC CONTOURS ARE APPROXIMATE.
 - ALL OWNERS ARE REQUIRED TO RETAIN ALL STORMWATER RUNOFF GENERATED BY IMPROVEMENTS TO THE PROPERTY. NO ADDITIONAL OR ALTERED FLOW IS PERMITTED ON NEIGHBOR PARCELS.
 - MAXIMUM ROOF ELEVATION AND BUILDING SETBACKS ARE DETERMINED BY MAUI COUNTY CODE.
 - THIS IS AN AGRICULTURALLY DESIGNATED AND ZONED PROPERTY. CONSULT HRS 205-4.5 AND MAUI COUNTY TITLE 19 FOR PERMITTED USES OF AGRICULTURAL LANDS.

PRELIMINARY PLOT PLAN

**MAHANALUA NUI SUB'D.
PHASE IV**

LAUNIUPOKO, LAHAINA, MAUI, HAWAII
 TMK: 2nd Div. 4-7-009:035, 036 & 037
 TMK: 2nd Div. 4-7-010:008, 009 & 010

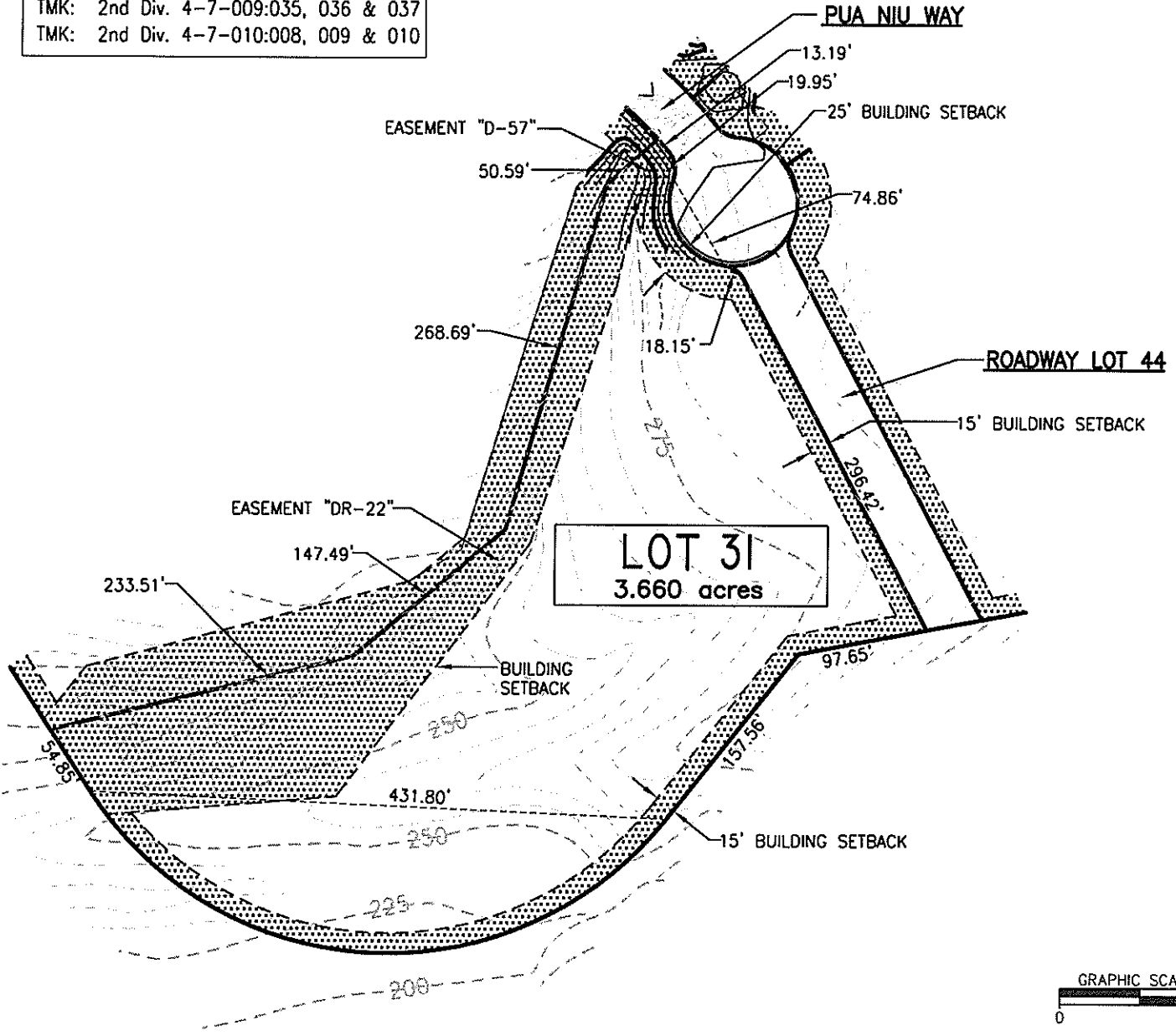
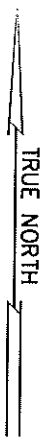

LEGEND	
	ARCH. BUFFER/ STREAMBED PARK
	SETBACK/EASEMENT
	100 YEAR FLOOD INUNDATION LIMITS
	NO ACCESS PERMITTED
	ACCESS PERMITTED

- NOTE:
1. ELEVATIONS DERIVED FROM CONSTRUCTION PLANS AND AERIAL TOPOGRAPHIC MAP. TOPOGRAPHIC CONTOURS ARE APPROXIMATE.
 2. ALL OWNERS ARE REQUIRED TO RETAIN ALL STORMWATER RUNOFF GENERATED BY IMPROVEMENTS TO THE PROPERTY. NO ADDITIONAL OR ALTERED FLOW IS PERMITTED ON NEIGHBOR PARCELS.
 3. MAXIMUM ROOF ELEVATION AND BUILDING SETBACKS ARE DETERMINED BY MAUI COUNTY CODE.
 4. THIS IS AN AGRICULTURALLY DESIGNATED AND ZONED PROPERTY. CONSULT HRS 205-4.5 AND MAUI COUNTY TITLE 19 FOR PERMITTED USES OF AGRICULTURAL LANDS.

PRELIMINARY PLOT PLAN

**MAHANALUA NUI SUB'D.
PHASE IV**

LAUNIUPOKO, LAHAINA, MAUI, HAWAII
 TMK: 2nd Div. 4-7-009:035, 036 & 037
 TMK: 2nd Div. 4-7-010:008, 009 & 010

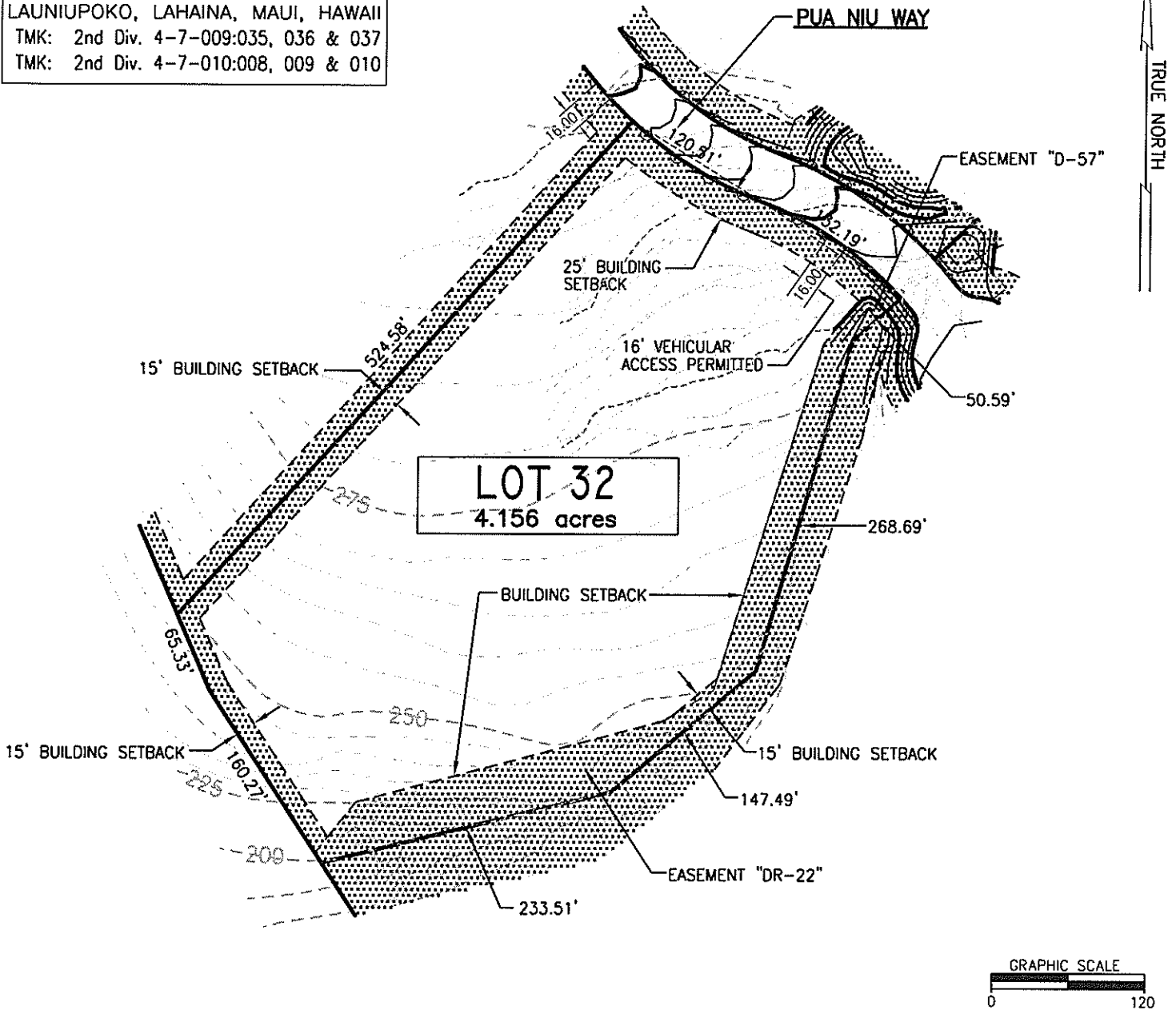

LEGEND	
	ARCH. BUFFER/ STREAMBED PARK
	SETBACK/EASEMENT
	100 YEAR FLOOD INUNDATION LIMITS
	NO ACCESS PERMITTED
	ACCESS PERMITTED

- NOTE:
- ELEVATIONS DERIVED FROM CONSTRUCTION PLANS AND AERIAL TOPOGRAPHIC MAP. TOPOGRAPHIC CONTOURS ARE APPROXIMATE.
 - ALL OWNERS ARE REQUIRED TO RETAIN ALL STORMWATER RUNOFF GENERATED BY IMPROVEMENTS TO THE PROPERTY. NO ADDITIONAL OR ALTERED FLOW IS PERMITTED ON NEIGHBOR PARCELS.
 - MAXIMUM ROOF ELEVATION AND BUILDING SETBACKS ARE DETERMINED BY MAUI COUNTY CODE.
 - THIS IS AN AGRICULTURALLY DESIGNATED AND ZONED PROPERTY. CONSULT HRS 205-4.5 AND MAUI COUNTY TITLE 19 FOR PERMITTED USES OF AGRICULTURAL LANDS.



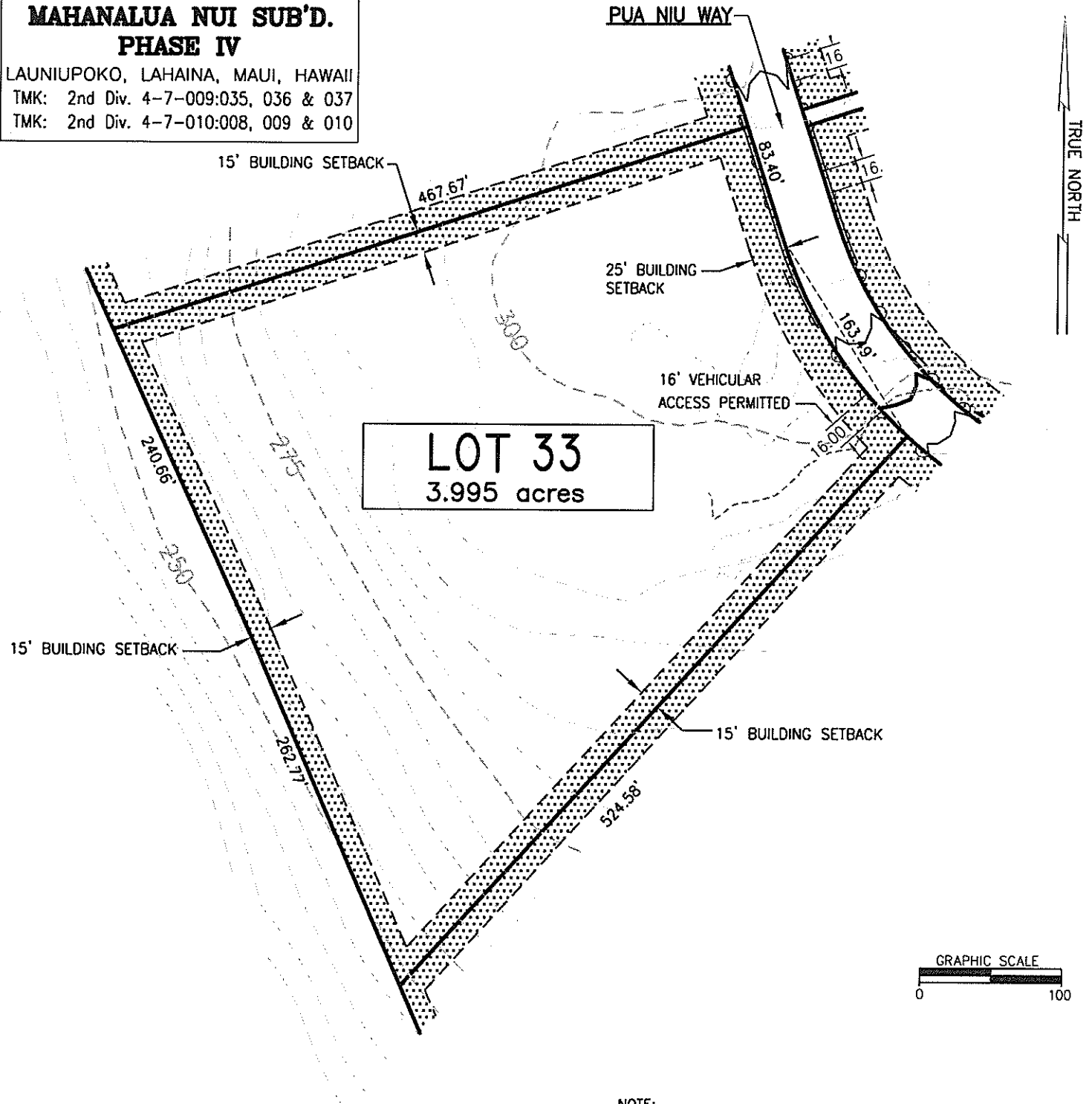

PRELIMINARY PLOT PLAN

**MAHANALUA NUI SUB'D.
PHASE IV**

LAUNIUPOKO, LAHAINA, MAUI, HAWAII
 TMK: 2nd Div. 4-7-009:035, 036 & 037
 TMK: 2nd Div. 4-7-010:008, 009 & 010



LOT 33
3.995 acres

LEGEND	
	ARCH. BUFFER/ STREAMBED PARK
	SETBACK/EASEMENT
	100 YEAR FLOOD INUNDATION LIMITS
	NO ACCESS PERMITTED
	ACCESS PERMITTED

- NOTE:
- ELEVATIONS DERIVED FROM CONSTRUCTION PLANS AND AERIAL TOPOGRAPHIC MAP. TOPOGRAPHIC CONTOURS ARE APPROXIMATE.
 - ALL OWNERS ARE REQUIRED TO RETAIN ALL STORMWATER RUNOFF GENERATED BY IMPROVEMENTS TO THE PROPERTY. NO ADDITIONAL OR ALTERED FLOW IS PERMITTED ON NEIGHBOR PARCELS.
 - MAXIMUM ROOF ELEVATION AND BUILDING SETBACKS ARE DETERMINED BY MAUI COUNTY CODE.
 - THIS IS AN AGRICULTURALLY DESIGNATED AND ZONED PROPERTY. CONSULT HRS 205-4.5 AND MAUI COUNTY TITLE 19 FOR PERMITTED USES OF AGRICULTURAL LANDS.

PRELIMINARY PLOT PLAN

**MAHANALUA NUI SUB'D.
PHASE IV**

LAUNIUPOKO, LAHAINA, MAUI, HAWAII

TMK: 2nd Div. 4-7-009:035, 036 & 037

TMK: 2nd Div. 4-7-010:008, 009 & 010

TRUE NORTH

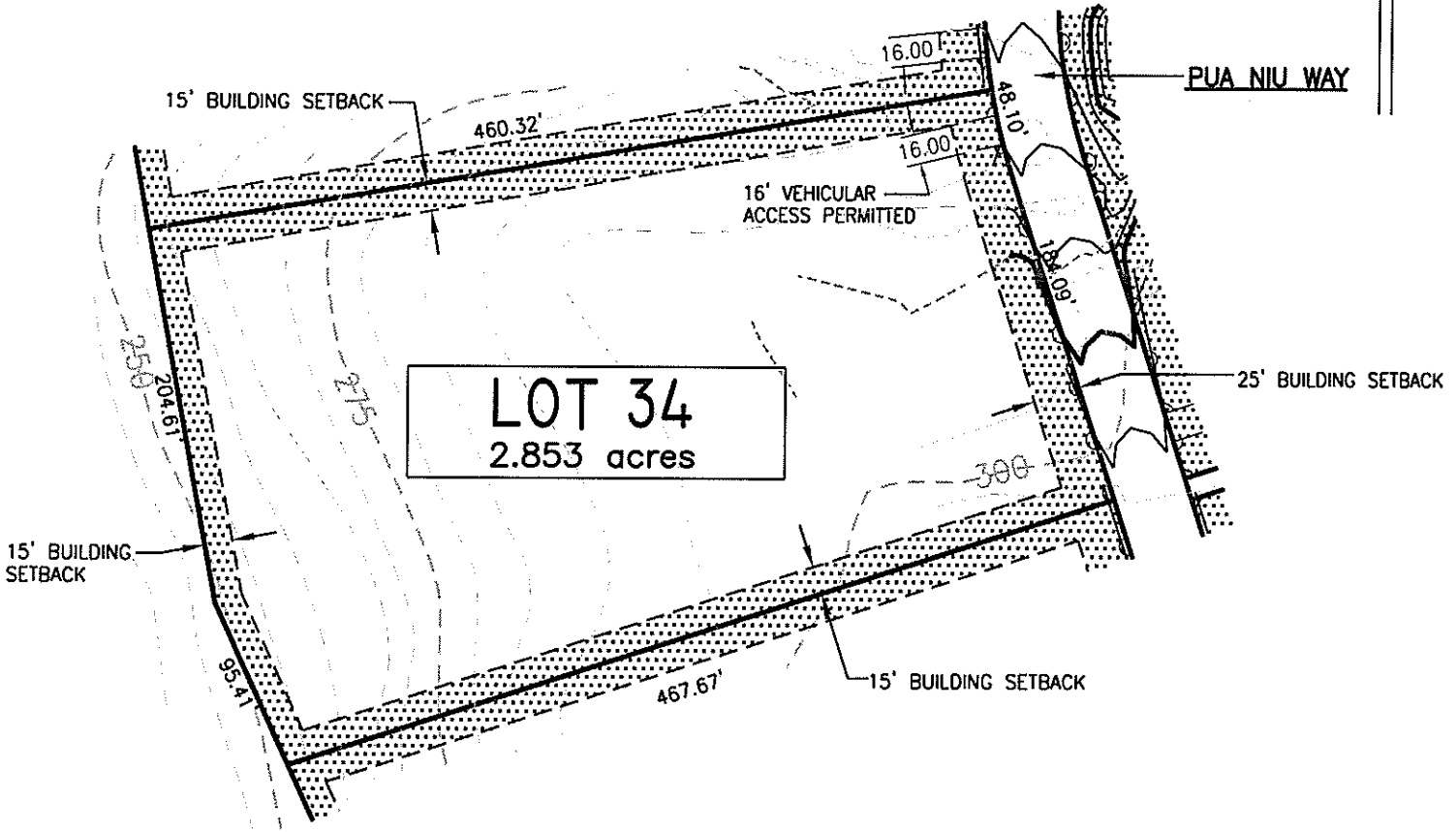

LOT 34
2.853 acres



NOTE:

1. ELEVATIONS DERIVED FROM CONSTRUCTION PLANS AND AERIAL TOPOGRAPHIC MAP. TOPOGRAPHIC CONTOURS ARE APPROXIMATE.
2. ALL OWNERS ARE REQUIRED TO RETAIN ALL STORMWATER RUNOFF GENERATED BY IMPROVEMENTS TO THE PROPERTY. NO ADDITIONAL OR ALTERED FLOW IS PERMITTED ON NEIGHBOR PARCELS.
3. MAXIMUM ROOF ELEVATION AND BUILDING SETBACKS ARE DETERMINED BY MAUI COUNTY CODE.
4. THIS IS AN AGRICULTURALLY DESIGNATED AND ZONED PROPERTY. CONSULT HRS 205-4.5 AND MAUI COUNTY TITLE 19 FOR PERMITTED USES OF AGRICULTURAL LANDS.

LEGEND	
	ARCH. BUFFER/ STREAMBED PARK
	SETBACK/EASEMENT
	100 YEAR FLOOD INUNDATION LIMITS
	NO ACCESS PERMITTED
	ACCESS PERMITTED

PRELIMINARY PLOT PLAN

**MAHANALUA NUI SUB'D.
PHASE IV**

LAUNIUPOKO, LAHAINA, MAUI, HAWAII
 TMK: 2nd Div. 4-7-009:035, 036 & 037
 TMK: 2nd Div. 4-7-010:008, 009 & 010

TRUE NORTH

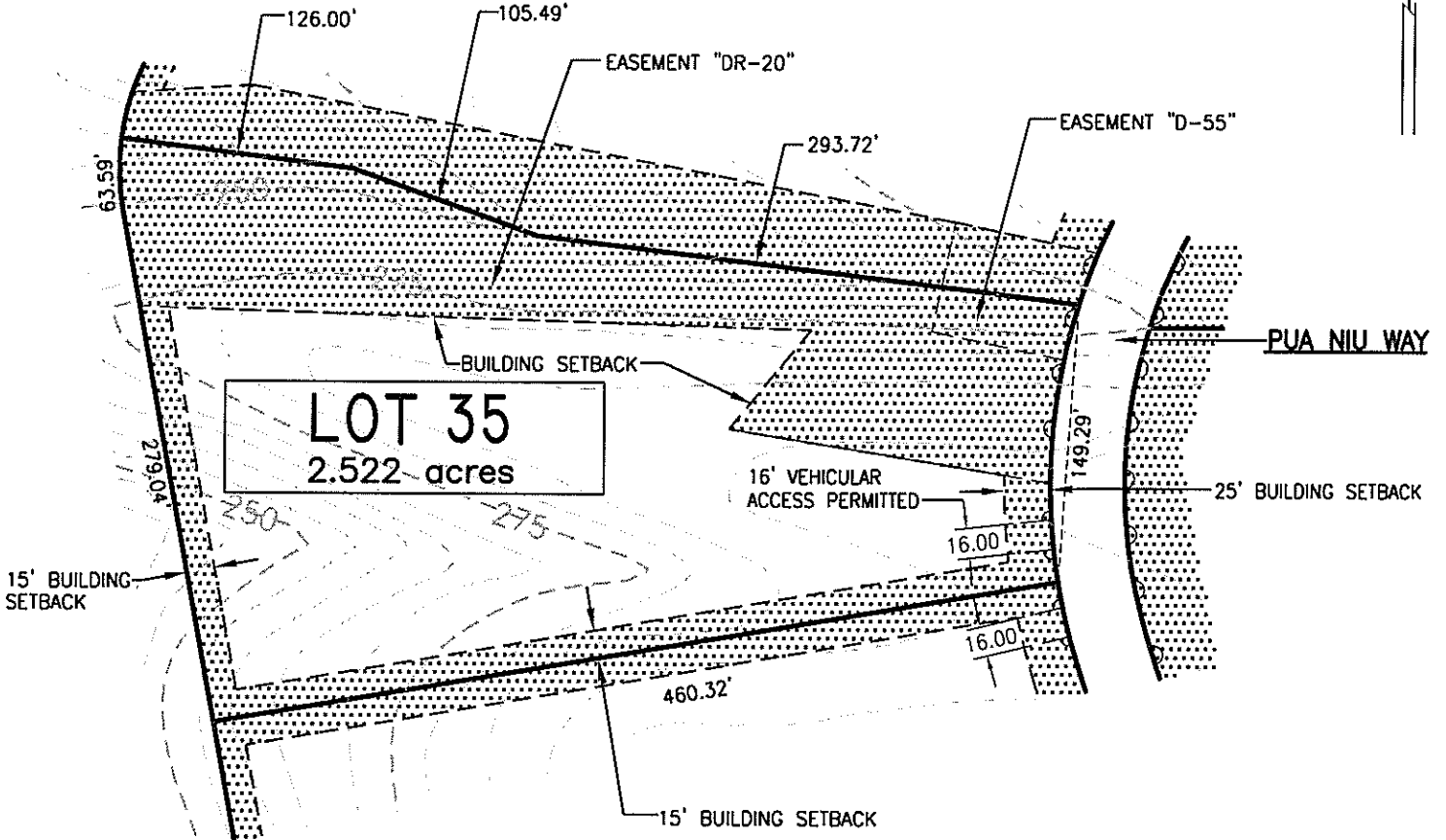

NOTE:

1. ELEVATIONS DERIVED FROM CONSTRUCTION PLANS AND AERIAL TOPOGRAPHIC MAP. TOPOGRAPHIC CONTOURS ARE APPROXIMATE.
2. ALL OWNERS ARE REQUIRED TO RETAIN ALL STORMWATER RUNOFF GENERATED BY IMPROVEMENTS TO THE PROPERTY. NO ADDITIONAL OR ALTERED FLOW IS PERMITTED ON NEIGHBOR PARCELS.
3. MAXIMUM ROOF ELEVATION AND BUILDING SETBACKS ARE DETERMINED BY MAUI COUNTY CODE.
4. THIS IS AN AGRICULTURALLY DESIGNATED AND ZONED PROPERTY. CONSULT HRS 205-4.5 AND MAUI COUNTY TITLE 19 FOR PERMITTED USES OF AGRICULTURAL LANDS.

LEGEND	
	ARCH. BUFFER/ STREAMBED PARK
	SETBACK/EASEMENT
	100 YEAR FLOOD INUNDATION LIMITS
	NO ACCESS PERMITTED
	ACCESS PERMITTED

PRELIMINARY PLOT PLAN

**MAHANALUA NUI SUB'D.
PHASE IV**

LAUNIUPOKO, LAHAINA, MAUI, HAWAII
 TMK: 2nd Div. 4-7-009:035, 036 & 037
 TMK: 2nd Div. 4-7-010:008, 009 & 010

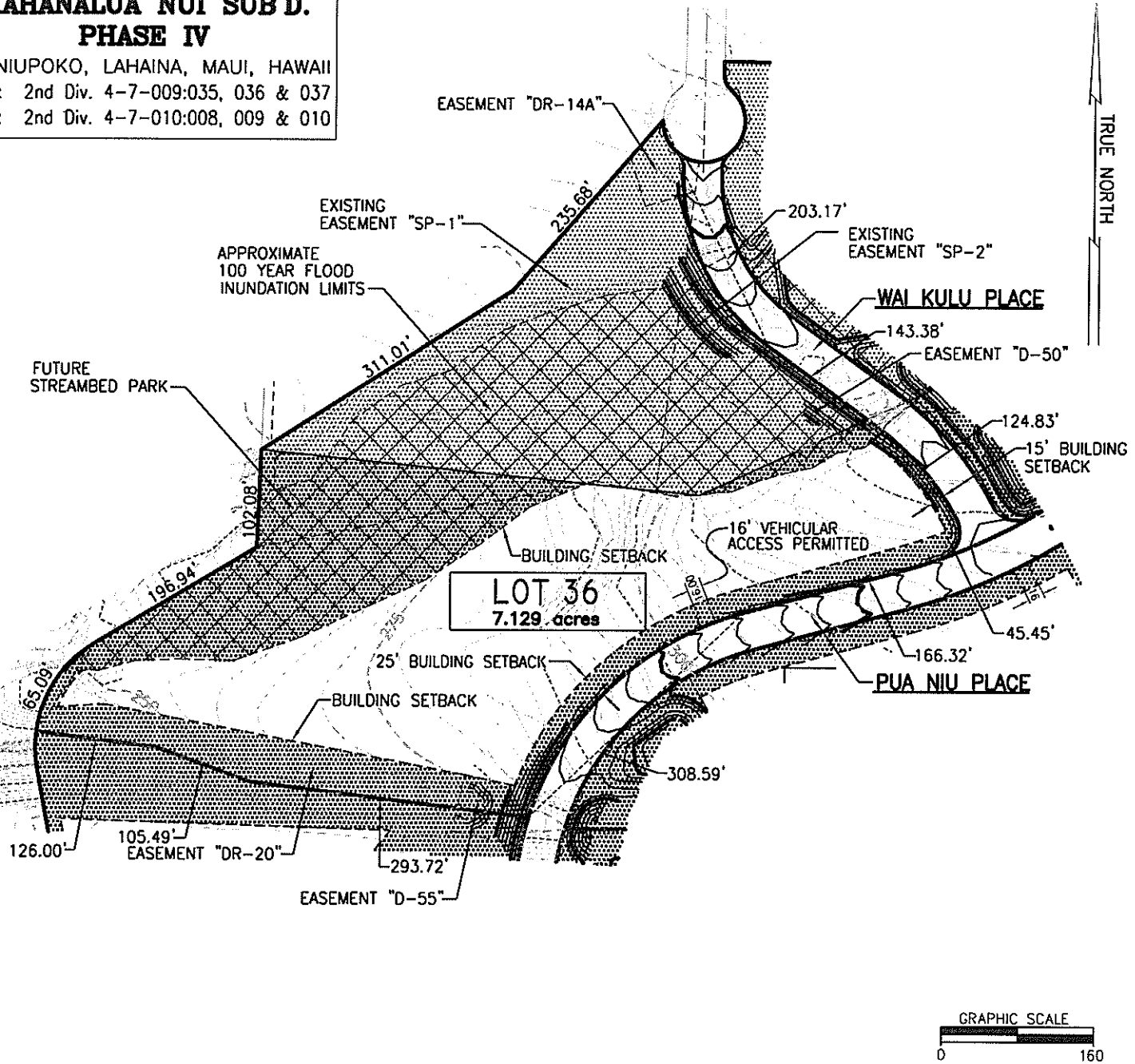

LEGEND	
	ARCH. BUFFER/ STREAMBED PARK
	SETBACK/EASEMENT
	100 YEAR FLOOD INUNDATION LIMITS
	NO ACCESS PERMITTED
	ACCESS PERMITTED

- NOTE:
- ELEVATIONS DERIVED FROM CONSTRUCTION PLANS AND AERIAL TOPOGRAPHIC MAP. TOPOGRAPHIC CONTOURS ARE APPROXIMATE.
 - ALL OWNERS ARE REQUIRED TO RETAIN ALL STORMWATER RUNOFF GENERATED BY IMPROVEMENTS TO THE PROPERTY. NO ADDITIONAL OR ALTERED FLOW IS PERMITTED ON NEIGHBOR PARCELS.
 - MAXIMUM ROOF ELEVATION AND BUILDING SETBACKS ARE DETERMINED BY MAUI COUNTY CODE.
 - THIS IS AN AGRICULTURALLY DESIGNATED AND ZONED PROPERTY. CONSULT HRS 205-4.5 AND MAUI COUNTY TITLE 19 FOR PERMITTED USES OF AGRICULTURAL LANDS.

PRELIMINARY PLOT PLAN